

Digital Panel Meters Modular Indicator and Controller Type UDM35



- Front protection degree: IP67, NEMA12
- Linearization of Hz inputs up to 16 points

- Multi-input modular instrument 3 1/2 DGT LED
- 0.1% RDG basic accuracy
- TRMS AC current and voltage measurements
- AC/DC current measurements: selectable full scales (200µA to 5A)
- AC/DC voltage measurements: selectable full scales (200mV to 500V)
- °C or °F temperature measurements (Pt100-250-500-1000, Ni100, TC J-K-S-T-E)
- Resistance measurements: selectable full scales (20Ω to 20kΩ)
- Dual rate, speed, frequency and period measurement (0.001Hz to 50kHz)
- Up to 4 independent alarm set-points (optional)
- 20mA/10VDC analog output (optional)
- Serial port RS485 or RS232 (optional)
- MODBUS, JBUS communication protocol

Product Description

µp-based digital panel meter, 3 1/2 DGT LED indicator, for current, voltage, temperature, resistance, rate, frequency, speed and period measurements. Measuring ranges and functions easily programmable from the key-pad or from the PC

by means of optional UdmSoft software. UDM35 includes storage min-max functions and double level protection password. Housing for panel mounting with front protection degree: IP67, NEMA12.

How to order

UDM35 XXX XX XX X XX

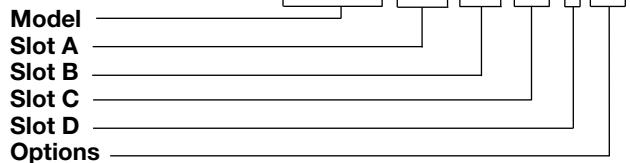

How to order

UdmSoft-kit

UdmSoft-kit: software plus communication cable for programming UDM35 by means of PC.

UdmSoft: software for programming UDM35/40/60 by means of PC, downloadable from www.carlogavazzi.com.

Type Selection

Slot A (measuring inputs)	Slot B (communication)	Slot C (communication and alarm)	Slot D (power supply)
LSX: signal inputs: 0.2-2-20mA DC/AC; 0.2-2-20V DC/AC LSE/LSF: signal inputs: + AUX: 0.2-2-20mA DC/AC; 0.2-2-20V DC/AC HSX: signal inputs: 0.2-2-5A DC/AC; 20-200-500V DC/AC TRX: signal inputs: TC temperature probes (J-K-S-T-E, Pt100-250-500-1000) and resistance (0.02-0.2-2-20kΩ) TF1: 0.001Hz to 50kHz for DC signals: PNP, NPN, NAMUR, TTL, free of voltage, contacts, voltages up to 14VDC TF2: 0.001Hz to 50kHz for AC signals: pick-up, voltages up to 500VAC	XX: None SX: Serial port RS485 SY: Serial port RS232 AV(*): Single analogue output, 0 to 20mA DC and 0 to 10V DC (*): The two analogue outputs cannot be used at the same time. It is possible to plug in only one module by instrument.	XX: None R1: Single relay output, (AC1-8AAC, 250VAC) R2: Dual relay output, (AC1-8AAC, 250VAC) R4: Dual relay output, (AC1-8AAC, 250VAC) + dual open collector output (NPN, 100mA) R5: 4 relay outputs (AC1-5AAC, 250VAC) AV(*): Single analogue output, 0 to 20mA DC and 0 to 10V DC	H: 90 to 260V AC/DC L: 18 to 60V AC/DC 3: 10 to 28V DC Options XX: None TX: Tropicalization

Input specifications

Analogue inputs BQ LSX module BQ LSE/LSF module BQ HSX module BQ TRX module BQ TRX module BQTF1 module BQTF2 module	Channels and variable 1, mA and V DC/AC 1, mA and V DC/AC + AUX 1, A and V DC/AC 1, temperature 1, resistance 2, frequency 2, frequency	Display	BQxxx: 3 1/2 DGT, BQTFx: 4 DGT 7 segments height 14.2 mm
Digital inputs Number of inputs Use Contact reading signal Close contact resistance Open contact resistance Insulation	Incl. in the measuring module 1 (voltage-free) key-pad lock Display hold Reset of latch alarms BQ xxx: <0.1mA, <3.5V DC BQ LSE/BQ LSF: <2.5mA, <14V DC BQTF1: <6mA, <7VDC BQTF2: <0.25mA, <3VDC Max 1k Ω Min 500k Ω (BQTFx: 100k Ω) Non-insulated	Max and min indication	See table "Measurement accuracy, temperature drifts and max min indications"
Accuracy (display, RS485)	See table "Measuring accuracy", temperature drifts and minimum-maximum indications"	Measurements	Current, voltage, temperature, resistance and frequency. For the current and voltage measurements: TRMS measurement of distorted sine waves. Direct ≤ 3 ; $A_{Pmax}=1.7I_n$; $V_{Pmax}=1.7U_n$
Additional errors Humidity Input frequency Magnetic field	0.3% RDG (BQTFx: 0.05%), 60% to 90% R.H. 0.4% RDG, 62 to 440 Hz 0.5% RDG (BQTFx: 0.05%) @ 400 A/m	Input impedance	See table "input impedances and overloads"
Temperature drift	See table "Measurement accuracy, temperature drifts, and max/min indications"	Frequency	40 to 440 Hz
Sampling rate	500 samples/s @ 50 Hz (escl. BQTFx)	Overload	See table "input impedances and overloads"
Display refresh time	200 msec @ 50Hz (escl. BQTFx)	Compensation	Only temperature measurement module.
		RTD	- For Pt 100-250-500-1000, 3-wire connection: up to 10 Ω - For resistance measur. with 20 Ω range: up to max 0.1 Ω - For resistance measurements with $\geq 200\Omega$ range: up to max 10 Ω Internal cold junction, within temperature range from 0 to +50°C. Automatic or manual compensation from 0 to 50°C.
		TC	

Measurement accuracy, temp. drifts, max and min indications

All accuracies and min/max indications are referred to an ambient temp. range of 25°C \pm 5°C, rel. humidity \leq 60% and scale ratio (electrical/displayed scale) equal to 1. The conversion into °F is obtained acting on the electrical/displayed scale ratio.

Module	Inputs	Type	Accuracy	Temp. drift	Min. indication (■)	Max. indicat. (■)
BQ LSX/ BQ LSE/ BQ LSF	-200 μ A to +200 μ A -2mA to +2mA -20mA to +20mA -200mV to +200mV -2V to +2V -20V to +20V	DC/AC	DC: $\pm(0.1\%RDG+3DGT)$ 0% to 25% FS; $\pm(0.1\%RDG+2DGT)$ 25% to 110% FS. TRMS (da 45 a 65Hz)*: $\pm(0.3\%RDG+3DGT)$ 0% to 25% FS; $\pm(0.3\%RDG+2DGT)$ 25% to 110% FS.	± 150 ppm/°C	- 199.9 - 1.999 - 19.99 - 199.9 - 1.999 - 19.99	+ 199.9 + 1.999 + 19.99 + 199.9 + 1.999 + 19.99

* <45Hz >65Hz= $\pm(0.5\%RDG+3DGT)$ 0% to 25% FS; $\pm(0.5\%RDG+2DGT)$ 25% to 110% FS.

(■) The min. indication for TRMS measurement (AC or DC) is 0; it is possible to modify the decimal point position.

Measurement accuracy, temp. drifts, max and min indications (cont.)

All accuracies and min/max indications are referred to an ambient temp. range of 25°C ±5°C, rel. humidity ≤60% and scale ratio (electrical/displayed scale) equal to 1. The conversion into °F is obtained acting on the electrical/displayed scale ratio.

Module	Inputs	Type	Accuracy	Temp. drift	Min. indication (■)	Max. indicat. (■)
BQ HSX	-200mA to +200mA -2A to +2A -5A to +5A -20V to +20V -200V to +200V -500V to +500V	DC/AC	DC: ±(0.1%RDG+3DGT) 0% to 25% FS; ±(0.1%RDG+2DGT) 25% to 110% FS. TRMS (45 to 65Hz)*: ±(0.3%RDG+3DGT) 0% to 25% FS; ±(0.3%RDG+2DGT) 25% to 110% FS.	±150 ppm/°C	- 199.9 - 1.999 - 5.00 - 19.99 - 199.9 - 500	+ 199.9 + 1.999 + 5.00 + 19.99 + 199.9 + 500
BQ TRX Thermo- couple	-50°C to +760°C -58 °F to +1400 °F -200°C to +1260°C -328 °F to +2300°F -200°C to +1000°C -328°F to +1832°F -50°C to +1750°C -58°F to +3182°F -200°C to +400°C -328°F to +752°F	J J K K E E S S T T	±(0.2%RDG+1DGT) ±(0.2%RDG+2DGT) ±(0.2%RDG+2DGT) ±(0.2%RDG+4DGT) ±(0.2%RDG+2DGT) ±(0.2%RDG+4DGT) ±(0.2%RDG+2DGT) ±(0.2%RDG+4DGT) ±(0.2%RDG+2DGT) ±(0.2%RDG+4DGT)	±150 ppm/°C	- 50°C - 58°F - 200°C - 328°F - 200°C - 328°F - 50°C - 58°F - 200°C - 328°F	+ 760°C + 1400°F + 1260°C + 2300°F + 1000°C + 1832°F + 1750°C + 3182°F + 400°C + 752°F

* <45Hz >65Hz= ±(0.5%RDG+3DGT) 0% to 25% FS; ±(0.5%RDG+2DGT) 25% to 110% FS.

(■) The min. indication for TRMS measurement (AC or DC) is 0; it is possible to modify the decimal point position.

Module	Inputs	Type	Accuracy	Temp. drift	Min. indication	Max. indicat.
BQ TRX Ther- moresis- tance	-200°C to +850°C -328°F to +1562°F -200.0°C to +200.0°C -328°F to +392°F -200.0°C to +200.0°C -328°F to +392°F -200.0°C to +200.0°C -328°F to +392°F -200.0°C to +200.0°C -328°F to +392°F -60°C to +180°C -76°F to +356°F	Pt100 Pt100 Pt100 Pt100 Pt250 Pt250 Pt500 Pt500 Pt1000 Pt1000 Ni100 Ni100	±(0.2%RDG +2DGT) ±(0.2%RDG +4DGT) ±(0.5%RDG +5DGT) ±(0.5%RDG +5DGT) ±(0.5%RDG +5DGT) ±(0.5%RDG +5DGT) ±(0.5%RDG +5DGT) ±(0.5%RDG +5DGT) ±(0.5%RDG +5DGT) ±(0.5%RDG +5DGT) ±(0.5%RDG +1DGT) ±(0.5%RDG +2DGT)	±150 ppm/°C	- 200 - 328 - 200.0 - 328.0 - 200.0 - 328.0 - 200.0 - 328.0 - 200.0 - 328.0 - 60 - 76	+ 850 + 1562 + 200.0 + 392.0 + 200.0 + 392.0 + 200.0 + 392.0 + 200.0 + 392.0 + 180 + 356
BQ TRX Resis- tance	0 to 20Ω 0 to 200Ω 0 to 2000Ω 0 to 20.00kΩ		±(0.2%RDG+2DGT) 25% to 110% FS ±(0.2%RDG+3DGT) 0% to 25% FS	±150 ppm/°C	0 0 0 0	19.99 (■) 199.9 (■) 1999 (■) 19.99 (■)
BQ TF1	NPN (DC) PNP (DC) NAMUR (DC) TTL (DC) Free of voltage con- tact (DC)		0.001% RDG ±3 digit	± 50 ppm/°C	0.000 (*) 00.00 (*) 000.0 (*) 0000 (*)	9.999 99.99 999.9 9999
BQ TF2	Pick-up (AC) Voltage (AC) up to 100VAC Voltage (AC) up to 500VAC		0.001% RDG ±3 digit	± 50 ppm/°C	0.000 (*) 00.00 (*) 000.0 (*) 0000 (*)	9.999 99.99 999.9 9999

(■) It is possible to modify the decimal point position.

(*) The min indication is -9.99999, ..., -999999 in case of "rotation speed detection" function

Input impedances and overloads

Module	Inputs	Type	Impedance	Overload (continuous)	Overloads (1s)
BQ LSX/ BQ LSE/ BQ LSF	-200 μ A to +200 μ A -2mA to +2mA -20mA to +20mA -200mV to +200mV -2V to +2V -20V to +20V	DC/AC DC/AC DC/AC DC/AC DC/AC DC/AC	$\leq 2,2k\Omega$ $\leq 22\Omega$ $\leq 22\Omega$ $\geq 2,2k\Omega$ $\geq 200k\Omega$ $\geq 200k\Omega$	5mA 50mA 50mA 10V 50V 50V	10mA 150mA 150mA 20V 100V 100V
BQ HSX	-200mA to +200mA -2A to +2A -5A to +5A -20V to +20V -200V to +200V -500V to +500V	DC/AC DC/AC DC/AC DC/AC DC/AC DC/AC	$\leq 1\Omega$ $\leq 0.012\Omega$ $\leq 0.012\Omega$ $\geq 2M\Omega$ $\geq 2M\Omega$ $\geq 2M\Omega$	0.8A 7.5A 7.5A 750V 750V 750V	1A 100A 100A 1000V 1000V 1000V
BQ TRX Thermo- couple	-50°C to +760°C -58 °F to +1400 °F -200°C to +1260°C -328 °F to +2300°F -200°C to +1000°C -328°F to +1832°F -50°C to +1750°C -58°F to +3182°F -200°C to +400°C -328°F to +752°F	J J K K E E S S T T	$I_{LK} < 0.5\mu A$	Max 5V	Max 10V
BQ TRX Thermo- resistance	-200°C to +850°C -328°F to +1562°F -200.0°C to +200,0°C -328°F to +392°F -200.0°C to +200,0°C -328°F to +392°F -60°C to +180°C -76°F to +356°F	Pt100 Pt100 Pt250/Pt100 Pt250/Pt100 Pt1000/Pt500 Pt1000/Pt500 Ni100 Ni100	800 μ A (*) 800 μ A (*) 90 μ A (*) 90 μ A (*) 800 μ A (*) 800 μ A (*) 800 μ A (*) 800 μ A (*)	Max 5V	Max 10V
BQ TRX Resistance	0 to 20 Ω 0 to 200 Ω 0 to 2000 Ω 0 to 20.00k Ω		800 μ A (*) 90 μ A (*) 800 μ A (*) 90 μ A (*)	Max 5V	Max 10V
BQ TF1	NPN (DC) PNP (DC) NAMUR (DC) TTL (DC) Free of voltage contact (DC)		600 Ω 600 Ω 600 Ω 600 Ω	15 VAC/DC 15 VAC/DC 15 VAC/DC 15 VAC/DC 15 VAC/DC	20 VAC/DC 20 VAC/DC 20 VAC/DC 20 VAC/DC 20 VAC/DC
BQ TF2	Pick-up (AC) Voltage (AC) up to 100VAC Voltage (AC) up to 500VAC		220 k Ω 950 k Ω	120 VAC/DC 600 VAC/DC	200 VAC/DC 600 VAC/DC

(*) Maximum measuring current generated for resistance equal to 0

Output specifications

RS422/RS485 Serial output LED Connections Distance Terminalization Addresses Protocol Data (bidirectional) Dynamic (reading only) Static (reading/writing) Data format Baud rate Insulation	(on request) Module: BR SX Bidirectional (static and dynamic variables). Display of data reception/transmission Multidrop, 2 or 4 wires, 1000 m Directly on the module by means of jumper 1 to 255, selectable by means of key-pad MODBUS RTU/JBUS Measurement, min value max value alarm status All programming parameters, min max reset reset of latch alarm 8 data bit, no parity, 1 stop bit selectable 4800, 9600, 19200 and 38400 bit/s By means of opto-couplers 4000 V _{rms} output to measuring inputs 4000 V _{rms} output to power supply input	BO R4 (2 relay outputs + Relay output BO R1, R2, R4 Relay output BO R5 Insulation Open collector output Insulation	2 open collector outputs). BO R5 (4 relay outputs) Type SPDT AC 1: 8A, 250VAC DC 12: 5A, 24VDC AC 15: 2.5A, 250VAC DC 13: 2.5A, 24VDC Type SPST (NO) AC 1: 5A, 250VAC DC 12: 3A, 24VDC AC 15: 1.5A, 250VAC DC 13: 1.5A, 24VDC 4000 V _{RMS} output to measuring input, 4000 V _{RMS} output to power supply input. NPN transistor type V _{ON} 1.2 VDC/ max. 100 mA V _{OFF} 30 VDC max. By means of opto-couplers 4000 V _{RMS} output to measuring input 4000 V _{RMS} output to power supply input
RS232 Serial output Connections Distance Data format Baud rate Other features	(on request) Module: BR SY Bidirectional (static and dynamic variables) 3 wires, max. 15m 1 start bit, 8 data bit, no parity, 1 stop bit Selectable 4800, 9600, 19200 and 38400 bit/s Same as RS422/485	Analogue output Range Scaling factor Accuracy Response time Temperature drift Load: 20 mA output 10 V output Insulation	(on request) Module: BO AV 0 to 20 mADC, 0 to 10 VDC Programmable within the entire retransmission range; allows to manage the retransmission of all the values from 0 to 20 mA / 0 to 10V ± 0.2% FS (@ 25°C ± 5°C) ≤ 10 ms ± 200 ppm/°C ≤ 700 Ω ≥ 10 kΩ By means of opto-couplers 4000V _{rms} output to measuring input 4000V _{rms} output to power supply input
Alarm outputs Alarm type Alarm set-point Hysteresis On-time delay Off-time delay Output status Min response time Output channels BO R2 (2 relay outputs).	(on request) Over-range alarm, up alarm, down alarm, down alarm with start-up deactivation up alarm with latch, down alarm with latch Adjustable from 0 to 100% of displayed electric range 0 to 100% of displayed range 0 to 255 s 0 to 255 s Selectable: normally energized /de-energized 500 ms, with filter excluded, without alarm activation delay 1 with module BO R1 (relay output). 2, independent with module 4, independent with module	Notes: Excitation output BQ LSE Module Voltage BQ LSF Module Voltage BQTF1 Module Voltage 1 Voltage 2 Insulation	(on request) 13 VDC ±10%, max. 50 mA 25 VDC ±10%, max. 25 mA 8.2VDC ±10%, max 10mA. 13VDC ±10%, max 40mA. 25V _{rms} output to measuring input 4000 V _{rms} output to power supply input



Software functions

Min / Max storage	Automatic storage (in the EEPROM) of the minimum and maximum measured value from the previous memory reset	Input engineering unit	BQTFx only: programmable among Hz, kHz, rpm, krpm, rph, krph
Password	Numeric code max 4 dgt 2 levels of data protection. 0 to 4999 completely protected. 5000 to 9999 access to programming is protected . Alarm set-points are directly programmable from the measuring mode.	Diagnostics	The display flashes when the limits of the display range are exceeded and the data are updated up to 20% of the rated display range. Only temperature inputs Opening of probe's connection: EEE indication Opening of probe's connection: EEE indication probe's short circuit: -EEE indication. Exceeding of frequency range: Err indication
1st level		Burn-out:	
2nd level		TC	
		RTD	
Measurement selection	Depending on the module: measuring range and type of probe (resistance, RTD thermoresistance, TC thermocouple) or measuring type (TRMS or DC).	BQTFx	
Function (only BQTFx)	Displayed functions of channel A and B: F1: scaled value of channel A; F2: 1/A; F3: A-B; F4: (A-B)/B*100; F5: A/B; F6: B/(A+B)+100; F7: rotation sensing.	Digital filter	Filter operating range 0 to 9999 Filtering coefficient 1 to 32
Integration time selection	Automatic or from 100.0 to 999.9 ms only in the current and voltage measurement. (BQTFx excluded)	Display selection	3 1/2 DGT or 3 DGT plus dummy zero (BQTFx excluded) 4 DGT on BQTFx
Scaling factors		Scaling	Selection of min value of the input range. Selection of max value of the input range. Selection of decimal point position. Selection of min display value. Selection of max display value.
Operating mode	Electrical scale compression, displayed scale compression/expansion (max. 2 without filter, up to 10 with filter)	UdmSoft	Software for programming UDM35 by means of PC (Windows 95, 98se, ME, XP) by means of serial port RS485 and relevant connection cable. The software is available in English, Spanish, Italian, German and French. See also "Programming of UDM35 by means of PC".
Electrical range	Programmable within the whole measuring range		
Decimal point position	Programmable within the display range		
Displayed range of the variable	Programmable within the display range		
Pulse per revolution	BQTFx only: programmable from 1 to 9999		

Supply Specifications

AC/DC voltage	90 to 260V (standard) 18 to 60V (on request)	Energy consumption	≤ 30VA/12W (90 to 260V) ≤ 20VA/12W (18 to 60V) ≤ 7.5W (10 to 28V)
DC voltage only	10 to 28V (on request)		

General Specifications

Operating temperature	0° to 50°C (32° to 122°F) (H.R. < 90% non-condensing)	Safety Standards	EN 61010-1, IEC 61010-1
Storage temperature	-10° to 60°C (14° to 140°F) (H.R. < 90% non-condensing)	Connections	Screw type Cable cross-section area Max. 2.5 mm ² ; Min./Max. screws tightening torque: 0.4 Nm / 0.6 Nm
Insulation reference voltage	300 V _{RMS} to ground (500V input)	Housing	Dimensions Material
Insulation	See table "Insulation between inputs and outputs"		1/8 DIN, 48 x 96 x 105 mm PC-ABS, self-extinguishing: UL 94 V-0
Dielectric strength	4000 V _{RMS} for 1 minute	Protection degree	Front: IP67, NEMA12 Connections: IP20
Rejection	NMRR CMRR	Weight	520 g approx (included all modules and packing)
	40 dB, 40 to 60 Hz 100 dB, 40 to 60 Hz	Approvals	CE, UR, CSA
EMC	EN61000-6-2, IEC61000-6-2 EN61000-6-3, IEC61000-6-3		

Excitation output

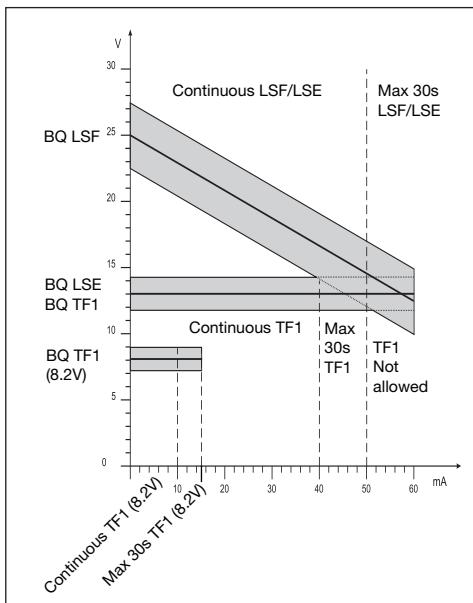

Insulation between inputs and outputs

	Meas. inputs	Relay output	Static output	Analogue output	Serial Port	AUX p.supply	90-260VAC/DC p.supply	18-60VAC/DC p.supply
Meas. inputs	-	4kV	4kV	4kV	4kV	25V	4kV	4kV
Relay Output	4kV	-	2kV	4kV	4kV	4kV	4kV	4kV
Static Output	4kV	2kV	-	4kV	4kV	4kV	4kV	4kV
Analogue Output	4kV	4kV	4kV	-	4kV	4kV	4kV	4kV
Serial Port	4kV	4kV	4kV	4kV	-	4kV	4kV	4kV
AUX p.supply	25V	4kV	4kV	4kV	4kV	-	4kV	4kV
90-260VAC/DC p.supply	4kV	4kV	4kV	4kV	4kV	4kV	-	-
18-60VAC/DC p.supply	4kV	4kV	4kV	4kV	4kV	4kV	-	-

Available modules

Type	N. of channels	Ordering code
UDM35 main unit		BD 35
DC/AC input: 200 μ A, 2mA, 20mA, 200mA, 2V, 20V	1	BQ LSX
DC/AC input: 200 μ A, 2mA, 20mA, 200mA, 2V, 20V + excitation output	1	BQ LSE/ BQ LSF
DC/AC input: 200mA, 2A, 5A, 20V, 200V, 500V	1	BQ HSX
Input: 20 Ω , 200 Ω , 2k Ω , 20k Ω	1	BQ TRX
TC: J-K-S-T-E, Pt100-250-500-1000	1	BQ TRX
Pulse signals input: 0.001Hz to 50kHz for DC signals	2	BQ TF1
Pulse signals input: 0.001Hz to 50kHz for AC signals	2	BQ TF2
Analogue output 0 to 20mA, 0 to 10VDC	1	BO AV
Relay output	1	BO R1
Relay output	2	BO R2
Outputs: 2 relays + 2 open collectors	4	BO R4
Relay output	4	BO R5
RS485 Serial Port	1	BR SX
RS232 Serial Port	1	BR SY
Power supply 18 to 60V AC/DC		BP L
Power supply 90 to 260V AC/DC		BP H
Power supply 10 to 28V DC		BP 3

Possible module combinations

Basic Unit	Slot A	Slot B	Slot C	Slot D
Measuring inputs: LSX, LSE, LSF, HSX, TRX, TF1, TF2	●			
RS485 Serial port: SX		●		
RS232 Serial port: SY		●		
Analogue output: AV (*)		●	●	
Relay outputs and/or open collector: R1, R2, R4, R5			●	
Power supply: H, L, 3				●

(*) Up to 1 module max.

Used calculation formulas

Only for TRMS Measurements

Instantaneous effective voltage (TRMS)

$$V_1 = \sqrt{\frac{1}{n} \cdot \sum_1^n (V_1)_i^2}$$

Instantaneous effective current (TRMS)

$$A_1 = \sqrt{\frac{1}{n} \cdot \sum_1^n (A_1)_i^2}$$

Wiring diagrams

Process signal wiring diagrams

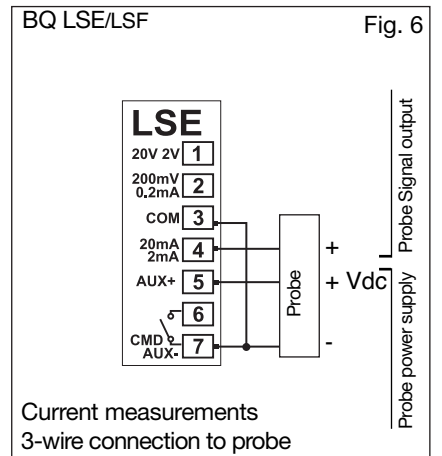
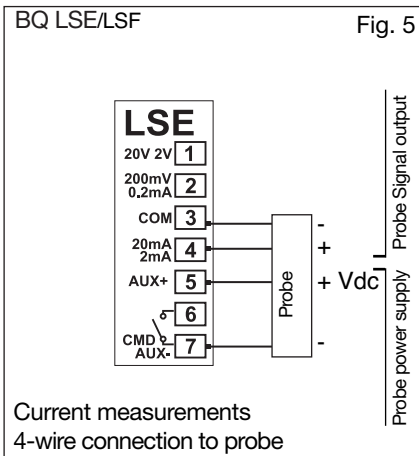
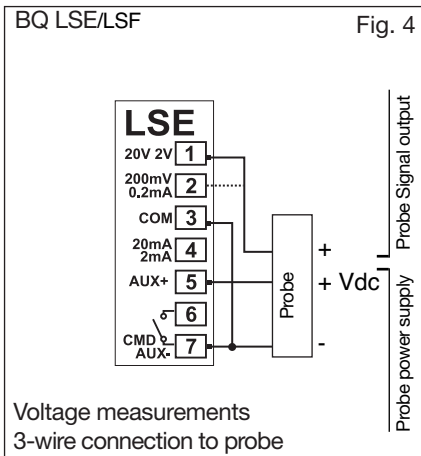
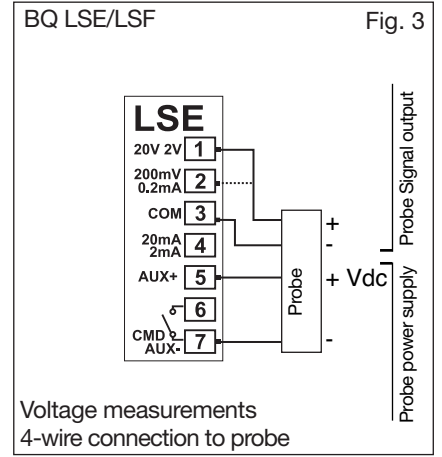
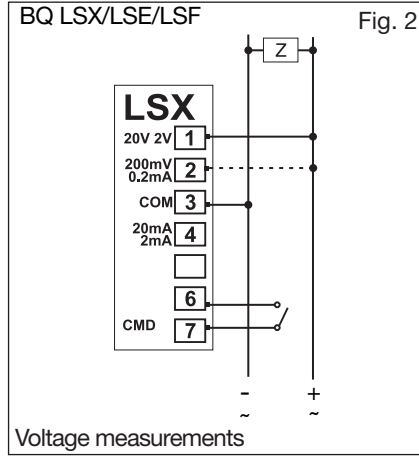
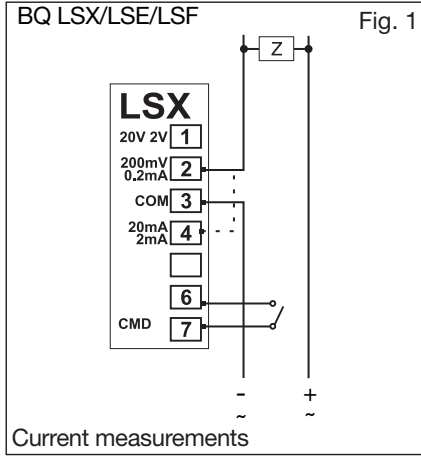

Wirings for high-level signals

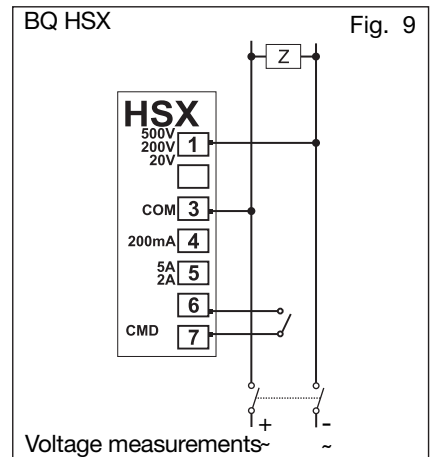
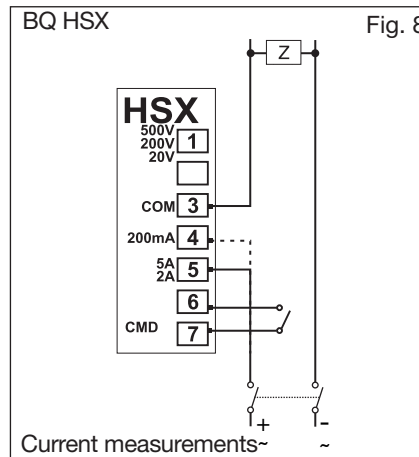
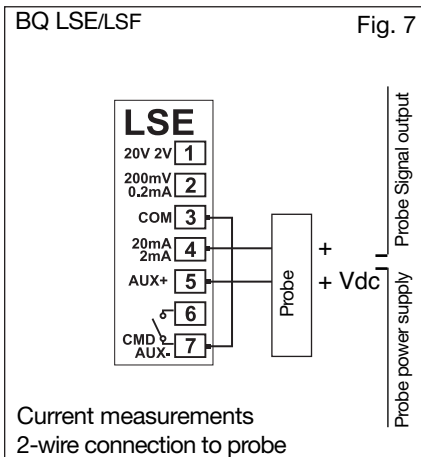

Wiring diagrams (cont.)

Wiring diagrams for temperature measurements

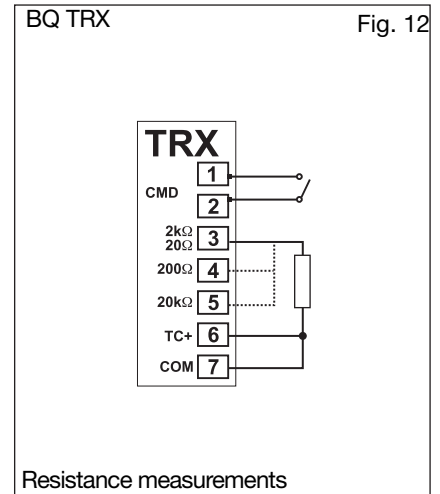
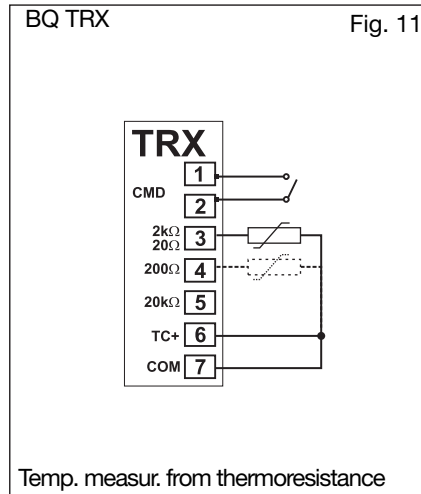
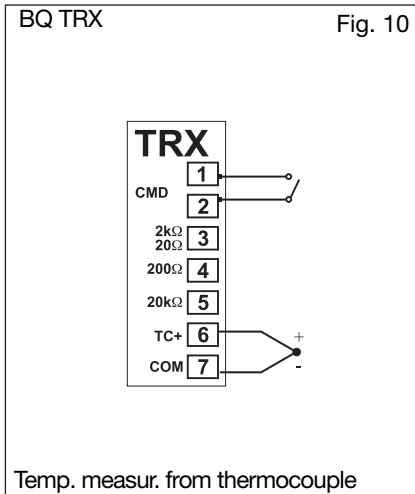

Wiring diagrams for frequency measurements

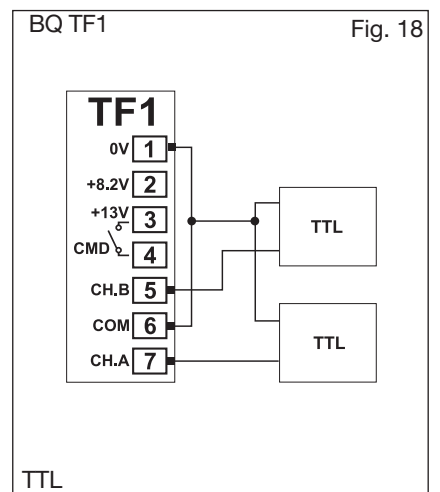
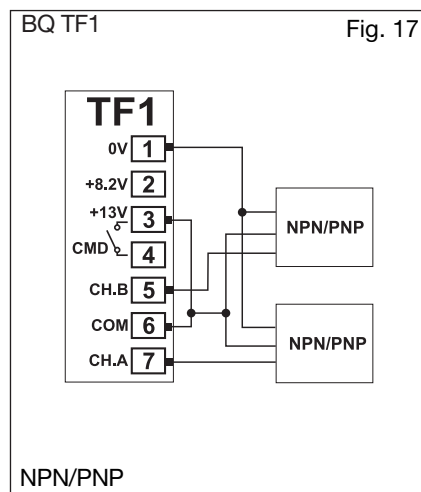
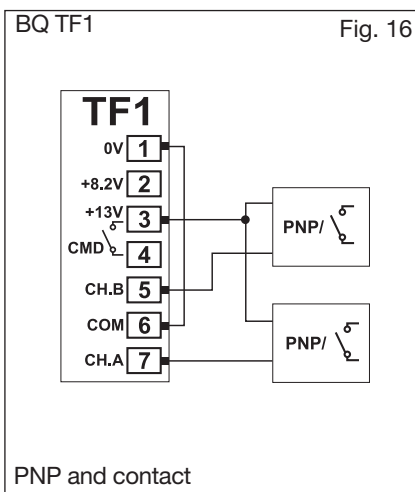
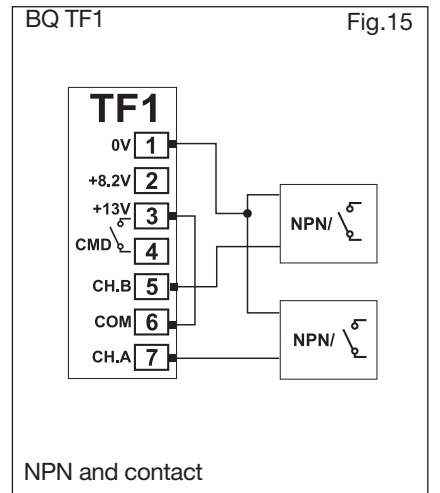
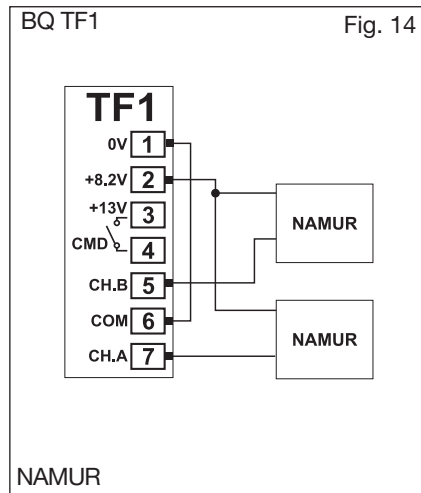
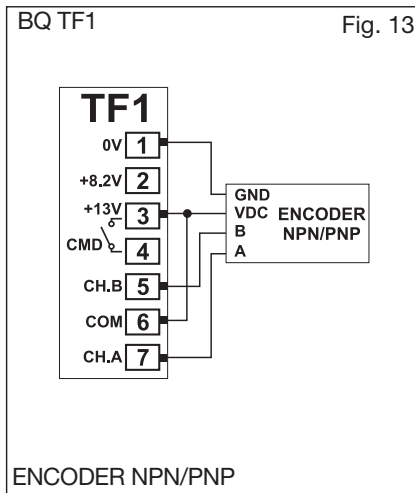

Wiring diagrams (cont.)

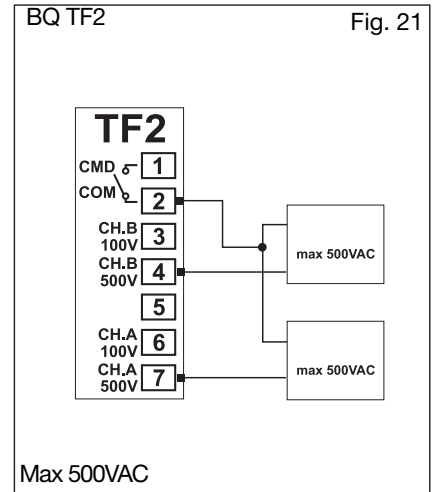
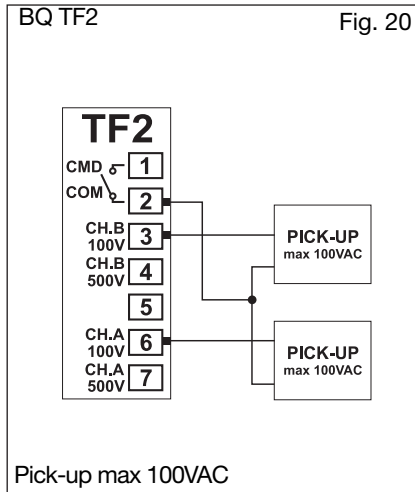
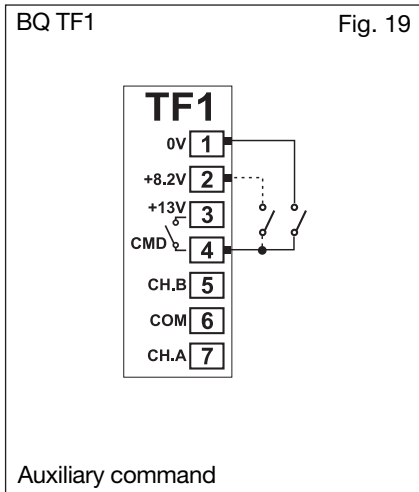

Wiring diagrams for power supply

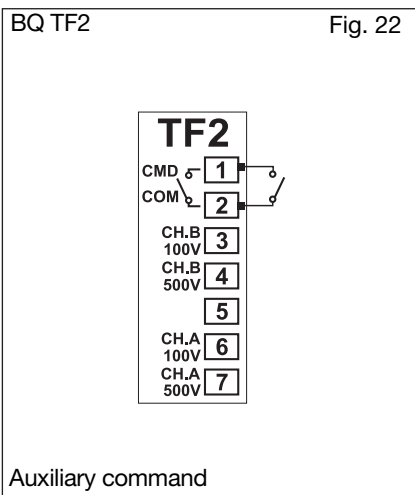

BP H: power supply

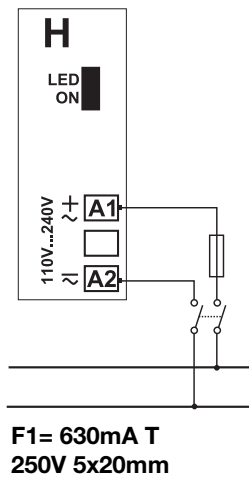

BP L: power supply

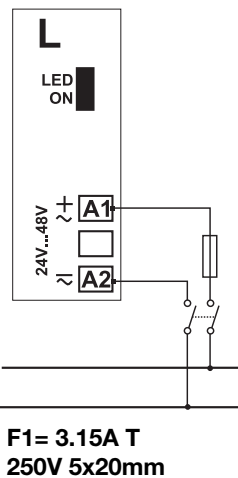

BP 3: power supply

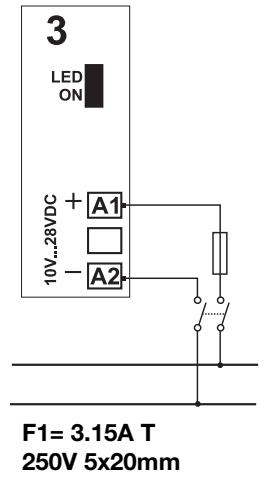

Wiring diagrams of optional modules

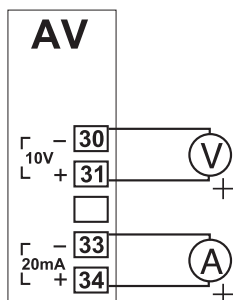

BO AV: analogue output (10V, 20mA DC)

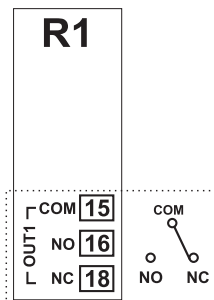

BO R1: 1 relay output

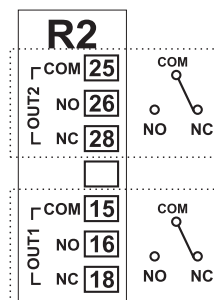

BO R2: 2 relay outputs

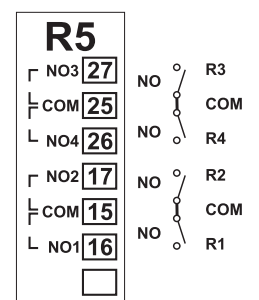

BO R5: 4 relay outputs

Wiring diagrams of optional modules (cont.)

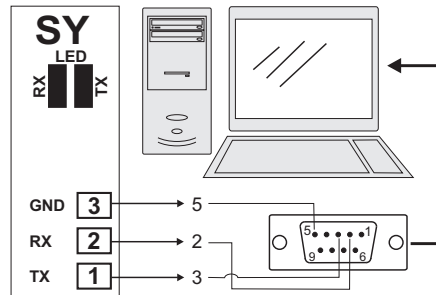
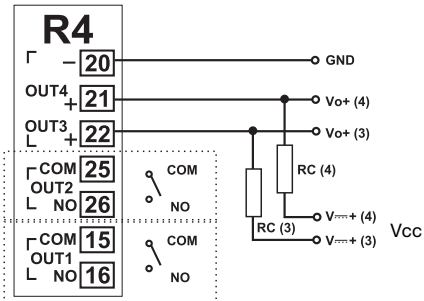

BO SY: RS232 direct connection to PC by means of COM port. RS232 has no termination.

BO R4: dual relay output + dual open collector output: the load resistances (R_c) must be designed so that the close contact current is lower than 100mA; the VDC voltage must be lower than or equal to 30VDC.

VDC: power supply output

Vo+: positive output (open collector transistor).

GND: ground (open collector transistor).

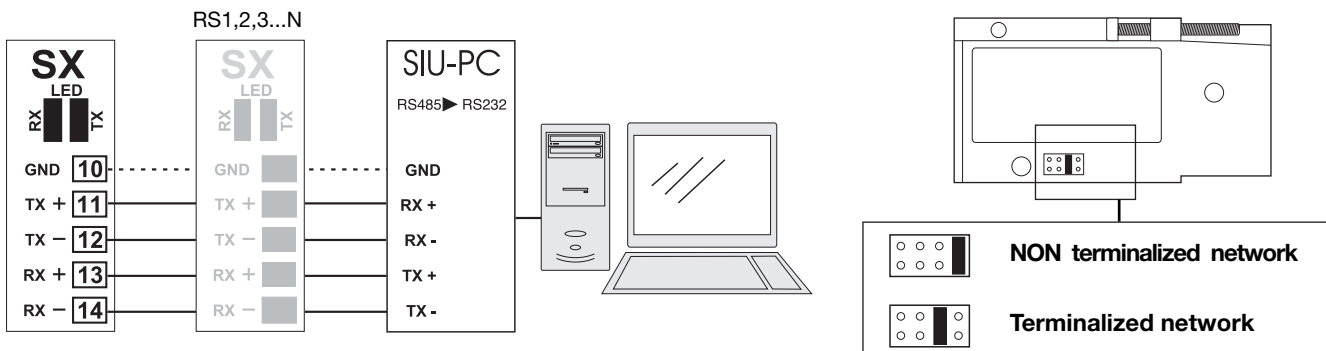

BR SX: RS485 4-wire connection: additional devices provided with RS485 port (indicated as RS1,2,3...N) are connected in parallel. The termination of the serial port is carried out only on the last instrument of the network. The serial module is provided with a jumper for the termination of the RS485 network as shown in the figure above.

Note: particular types of cables or plants may require an external termination. For the network connections use twisted cable type AWG26.

Programming UDM35 by means of PC

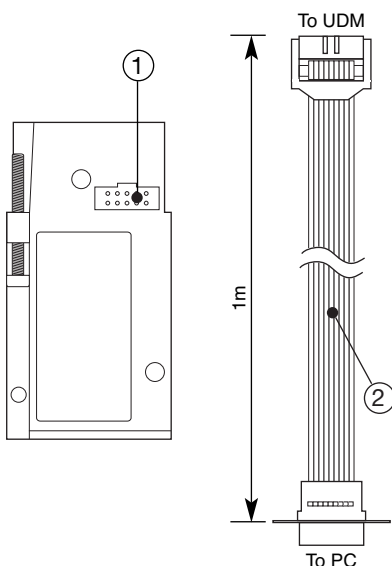

UDM35 is programmable by PC by means of the UdmSoft software (available on request). The user can program all parameters of UDM35 that will be subsequently uploaded and set in the instrument by the RS485 network (BRSX). Should UDM35 be without the RS485 serial module, all programming parameters will be uploaded and set in the instrument by the RS232 auxiliary serial connection (1) located on the side of the measuring input module using the special connection cable (2) available on request, as shown in the figures on the left. It is also possible to program the instrument using the dot connector (1) by means of the HyperTerminal Windows functions of a PC.

Note: the RS232 auxiliary port IS NOT insulated from the measuring inputs.

Front panel description

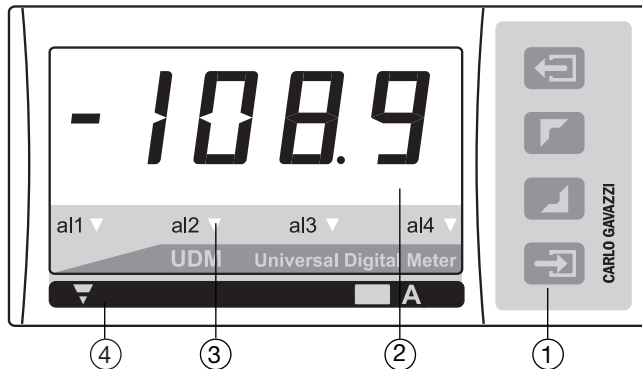

1. Key-pad

The programming of the configuration parameters and the display may be easily controlled by means of the 4 function keys.

: to enter the programming phase and to confirm the password.



- to program values;
 - to select functions;
 - to scroll display pages.
- : for special functions.

2. Display

Instantaneous measurements:

- 3 1/2 digit (max display 1999).
 - 4 digit (max display 9999) for tachometer measurements.
- Alphanumeric indications by means of LED display for:
- Display of configuration parameters;
 - The measured variable.

3. Alarm status LED

Display any alarm condition

4. Engineering unit

The instrument is supplied with a complete set of self-sticking labels with the main engineering units.

Dimensions

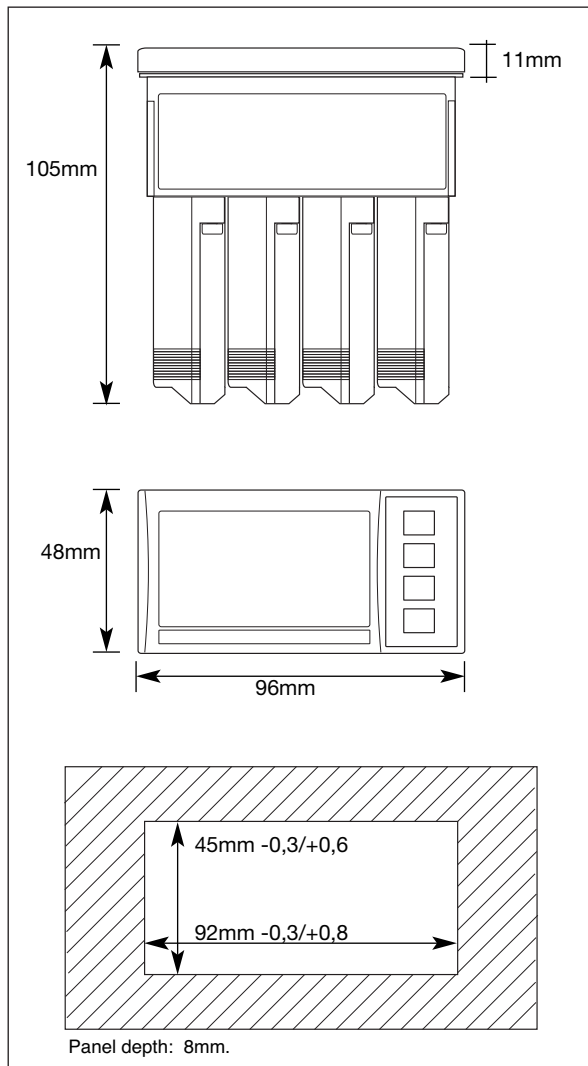

Engineering Units

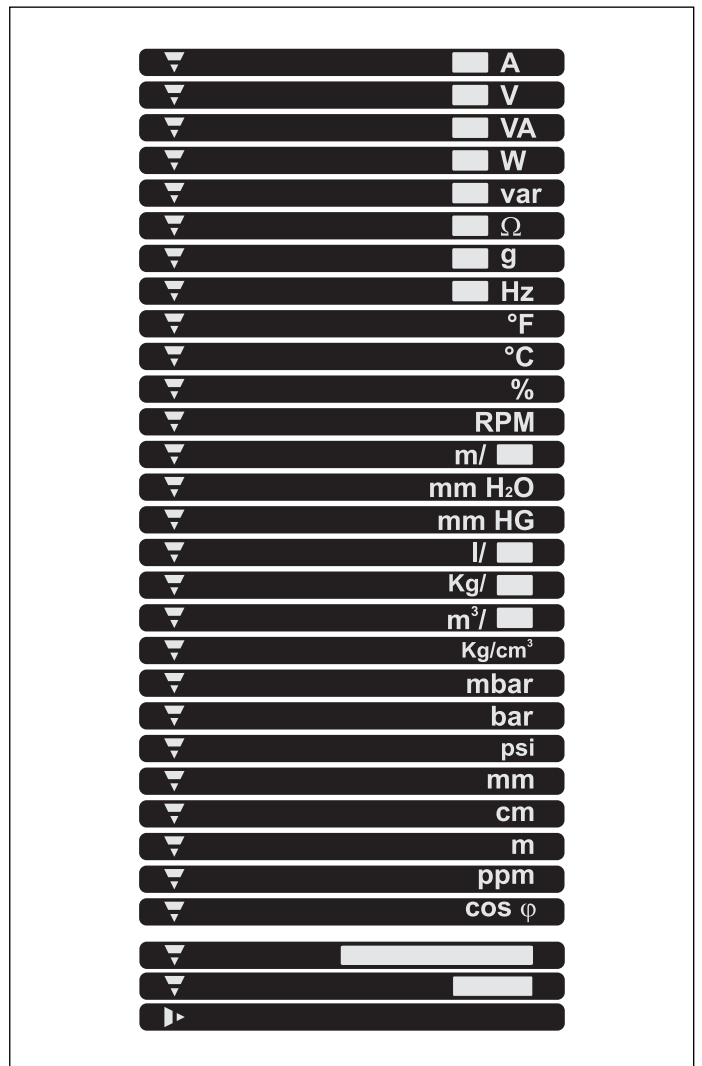

Modules

Input modules

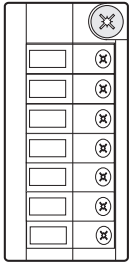

BQ LSX, BQ LSE, BQ LSF, BQ HSX, BQ TRX, BQ TF1, BQ TF2
Measuring inputs

Output modules

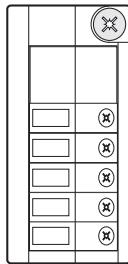

BO AV
Single analogue output 10V, 20mA DC

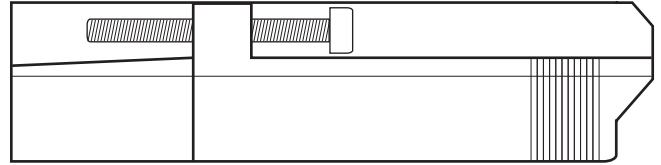

Scale 1:1

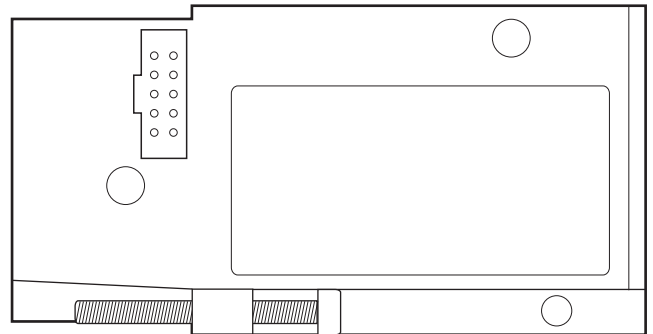

Output modules

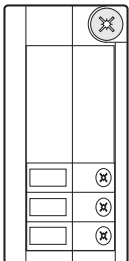

BO R1
Single relay output

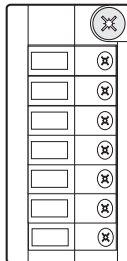

BO R2
Dual relay output

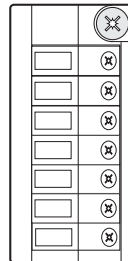

BO R4
Dual relay output + Dual open collector

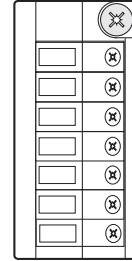

BO R5
4 relay outputs

Serial port modules

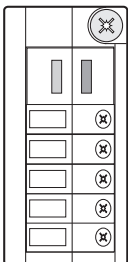

BR SX
RS485 Serial port

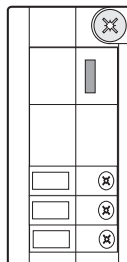

BR SY
RS232 Serial port

Power supply modules

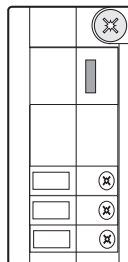

BP H
Power supply:
60 to 260V AC/DC

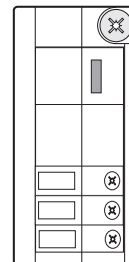

BP L
Power supply:
18 to 60V AC/DC

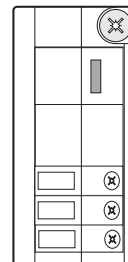

BP 3
Power supply:
10 to 28V DC