

iEM3100 / iEM3200 / iEM3300 series

Energy meters User manual

DOCA0005EN-04
04/2014



The information provided in this documentation contains general descriptions and/or technical characteristics of the performance of the products contained herein. This documentation is not intended as a substitute for and is not to be used for determining suitability or reliability of these products for specific user applications. It is the duty of any such user or integrator to perform the appropriate and complete risk analysis, evaluation and testing of the products with respect to the relevant specific application or use thereof. Neither Schneider Electric nor any of its affiliates or subsidiaries shall be responsible or liable for misuse of the information contained herein. If you have any suggestions for improvements or amendments or have found errors in this publication, please notify us.

No part of this document may be reproduced in any form or by any means, electronic or mechanical, including photocopying, without express written permission of Schneider Electric.

All pertinent state, regional, and local safety regulations must be observed when installing and using this product. For reasons of safety and to help ensure compliance with documented system data, only the manufacturer should perform repairs to components.

When devices are used for applications with technical safety requirements, the relevant instructions must be followed.

Failure to use Schneider Electric software or approved software with our hardware products may result in injury, harm, or improper operating results.

Failure to observe this information can result in injury or equipment damage.

© 2014 Schneider Electric. All rights reserved.

Safety information

Important information

Read these instructions carefully and look at the equipment to become familiar with the device before trying to install, operate, service or maintain it. The following special messages may appear throughout this bulletin or on the equipment to warn of potential hazards or to call attention to information that clarifies or simplifies a procedure.



The addition of either symbol to a “Danger” or “Warning” safety label indicates that an electrical hazard exists which will result in personal injury if the instructions are not followed.

This is the safety alert symbol. It is used to alert you to potential personal injury hazards. Obey all safety messages that follow this symbol to avoid possible injury or death.

DANGER

DANGER indicates an imminently hazardous situation which, if not avoided, **will** result in death or serious injury.

WARNING

WARNING indicates a potentially hazardous situation which, if not avoided, **can** result in death or serious injury.

CAUTION

CAUTION indicates a potentially hazardous situation which, if not avoided, **can** result in minor or moderate injury.

NOTICE

NOTICE is used to address practices not related to physical injury. The safety alert symbol shall not be used with this signal word.

Please note

Electrical equipment should be installed, operated, serviced and maintained only by qualified personnel. No responsibility is assumed by Schneider Electric for any consequences arising out of the use of this material.

A qualified person is one who has skills and knowledge related to the construction, installation, and operation of electrical equipment and has received safety training to recognize and avoid the hazards involved.

Notices

FCC Part 15 notice

This equipment has been tested and found to comply with the limits for a Class B digital device, pursuant to part 15 of the FCC Rules. These limits are designed to provide reasonable protection against harmful interference in a residential installation. This equipment generates, uses, and can radiate radio frequency energy and, if not installed and used in accordance with the instructions, may cause harmful interference to radio communications. However, there is no guarantee that interference will not occur in a particular installation. If this equipment does cause harmful interference to radio or television reception, which can be determined by turning the equipment off and on, the user is encouraged to try to correct the interference by one or more of the following measures:

- Reorient or relocate the receiving antenna.
- Increase the separation between the equipment and receiver.
- Connect the equipment to an outlet on a circuit different from that to which the receiver is connected.
- Consult the dealer or an experienced radio/TV technician for help.

This Class B digital apparatus complies with Canadian ICES-003.

About the book

Document scope

This manual is intended for use by designers, system builders and maintenance technicians with an understanding of electrical distribution systems and monitoring devices.

Validity note

The meters are used to measure the amount of active energy consumed by an installation or a part of an installation.

This function meets the requirements for:

- consumption monitoring,
- evaluation of energy items (cost, accounting, etc.).

This function may also satisfy the power-saving incentives implemented by many countries.

Related documents

Title of documentation	Reference number
Installation sheet: iEM3100 / iEM3110 / iEM3115	S1B46581 / S1B62907
Installation sheet: iEM3150 / iEM3155	S1B46583 / S1B62908
Installation sheet: iEM3200 / iEM3210 / iEM3215	S1B46598 / S1B62910
Installation sheet: iEM3250 / iEM3255	S1B46602 / S1B62911
Installation sheet: iEM3135	HRB68964 / HRB72100
Installation sheet: iEM3165	HRB68991 / HRB72106
Installation sheet: iEM3175	HRB68988 / HRB72103
Installation sheet: iEM3235	HRB68995 / HRB72108
Installation sheet: iEM3265	HRB69003 / HRB72111
Installation sheet: iEM3275	HRB68999 / HRB72109
Installation sheet iEM3310 / iEM3350	HRB91204 / HRB91205
Installation sheet iEM3335 / iEM3355 / iEM3365 / iEM3375	HRB91202 / HRB91203

You can download these technical publications and other technical information from www.schneider-electric.com.

Contents

	Safety information	4
	Notices	5
	About the book	6
	Contents	7
Chapter 1	Safety precautions	9
Chapter 2	Overview	11
	Overview of meter functions	11
	Typical applications	13
Chapter 3	Hardware and installation	15
	Dimensions	15
	Hardware overview	16
	DIN rail mounting and dismounting	22
	Input, output and communications wiring	24
	Power system wiring	26
Chapter 4	Front panel display and meter setup	33
	Overview	33
	Data display	33
	Resets	36
	Multi Tariff feature	36
	Meter status information	37
	The device clock	37
	Device configuration	38
	Modifying parameters	39
	Configuration mode menus	40
Chapter 5	Communications via Modbus RS-485	51
	Modbus communication overview	51
	Modbus functions	52
	Command interface	53
	Modbus register list	57
	Read Device Identification	61
Chapter 6	Communications via LonWorks	63
	LonWorks communications overview	63
	LonWorks communication implementation	63
	Standard network variable types (SNVTs) and configuration properties for reading data	64
	Meter configuration properties	68
	Echelon LonMaker plug-in for data display and meter configuration	71

Chapter 7	Communications via M-Bus	75
	M-Bus communications overview	75
	M-Bus protocol support	76
	M-Bus protocol implementation	76
	Variable data structure telegram information	77
	Telegram information for data records	79
	Telegram information for meter configuration	82
	M-Bus tool for data display and meter configuration	85
Chapter 8	Communications via BACnet	89
	BACnet communications overview	89
	BACnet protocol support	89
	BACnet communications implementation	90
	BACnet object and property information	91
Chapter 9	Specifications	97
	Electrical characteristics	97
	Mechanical characteristics	99
	Environmental characteristics	99
	Measurement accuracy	99
	MID	100
	Internal clock	100
	Modbus communications	100
	LonWorks communications	100
	M-Bus communications	101
	BACnet communications	101
Chapter 10	Troubleshooting	103
	Diagnosis screen	103
	Diagnostic codes	104
Chapter 11	Power, energy and power factor	105
	Power (PQS)	105
	Energy delivered (imported) / energy received (exported)	106
	Power factor (PF)	106
	Power factor register format	108

Chapter 1 Safety precautions

Installation, wiring, testing and service must be performed in accordance with all local and national electrical codes.

Carefully read and follow the safety precautions outlined below.

⚠ DANGER
HAZARD OF ELECTRIC SHOCK, EXPLOSION, OR ARC FLASH
<ul style="list-style-type: none">• Apply appropriate personal protective equipment (PPE) and follow safe electrical work practices. See NFPA 70E in the USA or applicable local standards.• This equipment must only be installed and serviced by qualified electrical personnel.• Turn off all power supplying this device and the equipment in which it is installed before working on the device or equipment.• Always use a properly rated voltage sensing device to confirm power is off.• Before performing visual inspections, tests, or maintenance on this equipment, disconnect all sources of electric power. Assume that all circuits are live until they have been completely de-energized, tested and tagged. Pay particular attention to the design of the power system. Consider all power supply sources, particularly the potential for backfeed.• Replace all devices, doors and covers before turning on power to this equipment.• Do not exceed the device's ratings for maximum limits.
Failure to follow these instructions will result in death or serious injury.

⚠ WARNING
UNINTENDED OPERATION
Do not use the meter for critical control or protection applications where human or equipment safety relies on the operation of the control circuit.
Failure to follow these instructions can result in death, serious injury or equipment damage.

⚠ WARNING
INACCURATE DATA RESULTS
<ul style="list-style-type: none">• Do not rely solely on data displayed on the front panel or in software to determine if the device is functioning correctly or compliant with all applicable standards.• Do not use data displayed on the front panel or in software as a substitute for proper workplace practices or equipment maintenance.
Failure to follow these instructions can result in death, serious injury or equipment damage.

Chapter 2 Overview

What is in this chapter?

This chapter contains the following topics:

Overview of meter functions 11

Typical applications 13

Overview of meter functions

The meters provide the essential measurement capabilities (for example, current, voltage, and energy) required to monitor a 1- or 3-phase electrical installation.

The key features of the meters are:

- measurement of active and reactive energy,
- Multi Tariffs (up to 4) controlled by internal clock, digital inputs or communication,
- MID compliance for many of the meters,
- pulse outputs,
- display (current, voltage, and energy measurements),
- communications via Modbus, LonWorks, M-Bus or BACnet protocols.

Main characteristics

63 A meters

Function		iEM3100	iEM3110	iEM3115	iEM3135	iEM3150	iEM3155	iEM3165	iEM3175
Direct measurement (up to 63 A)		√	√	√	√	√	√	√	√
Active Energy measurement accuracy class (total and partial kWh)		1	1	1	1	1	1	1	1
Four Quadrant Energy measurements		–	–	–	√	–	√	√	√
Electrical measurements (I, V, P, ...)		–	–	–	√	√	√	√	√
Multi Tariff	Controlled by internal clock	–	–	4	4	–	4	4	4
	Controlled by digital input(s)	–	–	4	2	–	2	2	2
	Controlled by communications	–	–	–	4	–	4	4	4
Measurement display (number of lines)		3	3	3	3	3	3	3	3
Digital inputs	Programmable (status, tariff control, or input monitoring)	–	–	–	1	–	1	1	1
	Tariff control only	–	–	2	–	–	–	–	–
Digital outputs	Programmable (energy pulsing or overload alarm)	–	–	–	1	–	1	1	–
	Pulse output only	–	1	–	–	–	–	–	–
Overload alarm		–	–	–	√	–	√	√	√
Communications	Modbus	–	–	–	–	√	√	–	–
	LonWorks	–	–	–	–	–	–	–	√
	M-Bus	–	–	–	√	–	–	–	–
	BACnet	–	–	–	–	–	–	√	–
MID compliant		–	√	√	√	–	√	√	√
Width (18 mm module in DIN rail mounting)		5	5	5	5	5	5	5	5

125 A meters

Function		iEM3300	iEM3310	iEM3335	iEM3350	iEM3355	iEM3365	iEM3375
Direct measurement (up to 125 A)		√	√	√	√	√	√	√
Active Energy measurement accuracy class (total and partial kWh)		1	1	1	1	1	1	1
Four Quadrant Energy measurements		-	-	√	-	√	√	√
Electrical measurements (I, V, P, ...)		-	-	√	√	√	√	√
Multi Tariff	Controlled by internal clock	-	-	4	-	4	4	4
	Controlled by digital input(s)	-	-	2	-	2	2	2
	Controlled by communications	-	-	4	-	4	4	4
Measurement display (number of lines)		3	3	3	3	3	3	3
Digital inputs (programmable for status, tariff control, or input monitoring)		-	-	1	-	1	1	1
Digital outputs	Programmable (energy pulsing or overload alarm)	-	-	1	-	1	1	-
	Pulse output only	-	1	-	-	-	-	-
Overload alarm		-	-	√	-	√	√	√
Communications	Modbus	-	-	-	√	√	-	-
	LonWorks	-	-	-	-	-	-	√
	M-Bus	-	-	√	-	-	-	-
	BACnet	-	-	-	-	-	√	-
MID compliant		-	√	√	-	√	√	√
Width (18 mm module in DIN rail mounting)		7	7	7	7	7	7	7

1 A / 5 A meters

Function		iEM3200	iEM3210	iEM3215	iEM3235	iEM3250	iEM3255	iEM3265	iEM3275
Measurement inputs through CTs (1 A, 5 A)		√	√	√	√	√	√	√	√
Measurement inputs through VTs		-	-	-	√	√	√	√	√
Active Energy measurement accuracy class (total and partial kWh)		0.5S	0.5S	0.5S	0.5S	0.5S	0.5S	0.5S	0.5S
Four Quadrant Energy measurements		-	-	-	√	-	√	√	√
Electrical measurements (I, V, P, ...)		-	-	-	√	√	√	√	√
Multi Tariff	Controlled by internal clock	-	-	4	4	-	4	4	4
	Controlled by digital input(s)	-	-	4	2	-	2	2	2
	Controlled by communications	-	-	-	4	-	4	4	4
Measurement display (number of lines)		3	3	3	3	3	3	3	3
Digital inputs	Programmable (status, tariff control, or input monitoring)	-	-	-	1	-	1	1	1
	Tariff control only	-	-	2	-	-	-	-	-
Digital outputs	Programmable (energy pulsing or overload alarm)	-	-	-	1	-	1	1	-
	Pulse output only	-	1	-	-	-	-	-	-

Function		iEM3200	iEM3210	iEM3215	iEM3235	iEM3250	iEM3255	iEM3265	iEM3275
Overload alarm		-	-	-	√	-	√	√	√
Communications	Modbus	-	-	-	-	√	√	-	-
	LonWorks	-	-	-	-	-	-	-	√
	M-Bus	-	-	-	√	-	-	-	-
	BACnet	-	-	-	-	-	-	√	-
MID compliant		-	√	√	√	-	√	√	√
Width (18 mm module in DIN rail mounting)		5	5	5	5	5	5	5	5

Typical applications

This range is a cost effective solution to monitor feeder circuits. These meters can monitor energy consumption by usage, by zone or by feeder in the cabinet. They can be used to monitor feeders in a main switchboard or to monitor the main in a distribution cabinet.

iEM31** and iEM33** series

Functions	Advantages
Can directly measure feeders up to: iEM31**: 63 A iEM33**: 125 A Embedded current transformers (CTs)	Saves installation time and space in the cabinet No wiring to manage Clear distribution network
Adapted to be installed with Acti9 iC65 (iEM31**) or Acti9 C120 (iEM33**) circuit breakers	Can be used in three-phase systems with or without neutral
Can be used for single-phase multi-circuit monitoring	3 single feeders can be monitored with a single meter

iEM32** series

Functions	Advantages
CT and VT connection	Can be used in low or medium voltage applications
Flexible configuration	Can be adapted to any distribution network with or without neutral

Typical applications

The following table presents some of the functions of the different meters, the advantages and main applications.

Functions	Advantages	Applications	Meter
Total and partial energy counters	Energy usage monitoring	Sub-billing management Metering applications	All
Internal clock	Saves the date and time of last reset	Provides the timestamp of the last reset of the partial energy accumulation	All (except iEM3100 / iEM3200 / iEM3300)
Pulse output with a configurable pulse weight of up to 1 pulse per 1 Wh	Collect pulses from the meter with a Smartlink system, PLC or any basic acquisition system	Remote monitoring of energy consumption Integrate the meter in to a system monitoring of a large number of devices	iEM3110 / iEM3310 / iEM3210
Manages up to four tariffs, controlled by the digital input(s), internal clock or communications (depending on meter model)	Categorize energy consumption into On Peak and Off Peak, working days and weekends, or by different electricity sources (for example, from the utility and an electrical generator)	Energy demand management Sub-billing management Identification of local energy consumption behavior by zone, by usage or by feeder	iEM3115 / iEM3135 / iEM3155 / iEM3165 / iEM3175 iEM3215 / iEM3235 / iEM3255 / iEM3265 / iEM3275 iEM3335 / iEM3355 / iEM3365 / iEM3375
Measures essential electrical parameters like current, average voltage and total power.	Instantaneous measurements help you monitor the imbalance between phases. Total power allows you to monitor the feeder load level.	Monitoring of feeders or any sub-cabinet	iEM3135 / iEM3155 / iEM3165 / iEM3175 iEM3235 / iEM3255 / iEM3265 / iEM3275 iEM3335 / iEM3355 / iEM3365 / iEM3375

Functions	Advantages	Applications	Meter
M-Bus communications	Communicate advanced parameters using M-Bus protocol	M-Bus network integration	iEM3135 / iEM3235 / iEM3335
Modbus communications	Communicate advanced parameters using Modbus protocol	Modbus network integration	iEM3150 / iEM3155 iEM3250 / iEM3255 iEM3350 / iEM3355
BACnet communications	Communicate advanced parameters using BACnet MS/TP protocol	BACnet network integration	iEM3165 / iEM3265 / iEM3365
LonWorks communications	Communicate advanced parameters using LonWorks communications	LonWorks network integration	iEM3175 / iEM3275 / iEM3375
Four quadrant calculation	Identification of imported and exported active and reactive energy allows you to monitor energy flow in both directions: delivered from the utility and produced on-site	Ideal for facilities with back-up generators or green power capabilities (for example, solar panels or wind turbines)	
Measurement of active, reactive and apparent energy.	Allows you to monitor energy consumption and production	Manage energy consumption and make informed investment to reduce your energy bill or penalties (for example, installing capacitor banks)	iEM3135 / iEM3155 / iEM3165 / iEM3175 iEM3235 / iEM3255 / iEM3265 / iEM3275
Programmable digital input	Can be programmed to: Count pulses from other meters (gas, water, etc.) Monitor an external status Reset the partial energy accumulation and start a new period of accumulation	This allows for monitoring of: WAGES Intrusion (for example, doors opening) or equipment status Energy usage	iEM3335 / iEM3355 / iEM3365 / iEM3375
Programmable digital output	Can be programmed to: be an active energy (kWh) pulse output, with a configurable pulse weight Alarm on a power overload at a configurable pickup setpoint	This allows you to: Collect pulses from the meter with a Smartlink system, PLC or any basic acquisition system Monitor power levels at a detailed level and to help detect an overload before the circuit breaker trips	iEM3135 / iEM3155 / iEM3165 iEM3235 / iEM3255 / iEM3265 iEM3335 / iEM3355 / iEM3365

Chapter 3 Hardware and installation

What is in this chapter?

This chapter contains the following topics:

- Dimensions** 15
- Hardware overview** 16
- DIN rail mounting and dismounting** 22
- Input, output and communications wiring** 24
- Power system wiring** 26

Dimensions

iEM31•• and iEM32•• meters

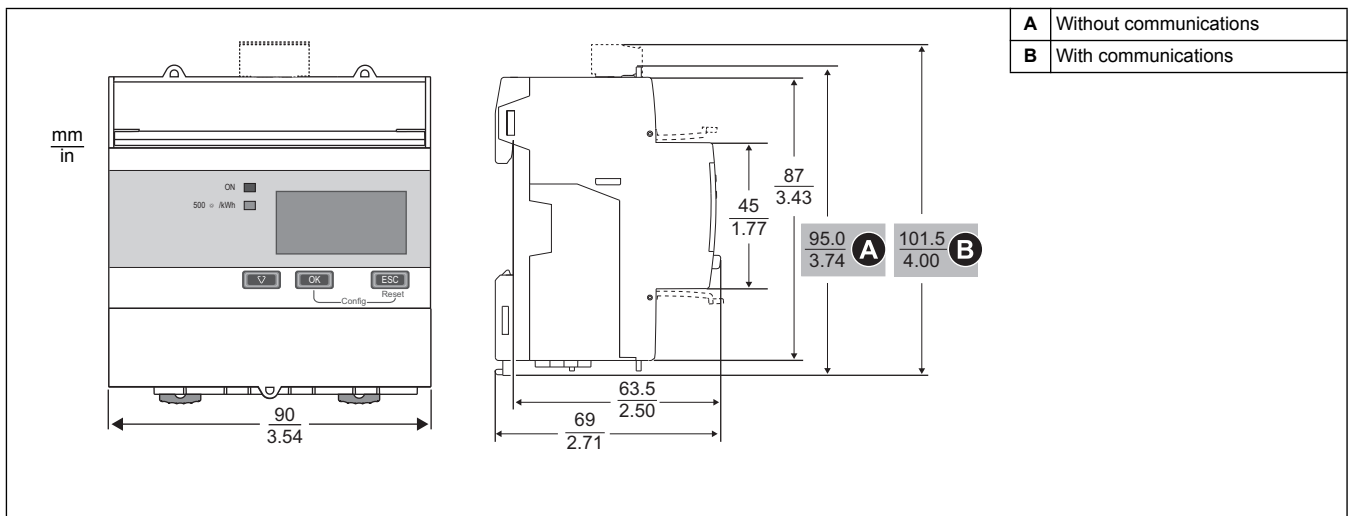

iEM33•• meters

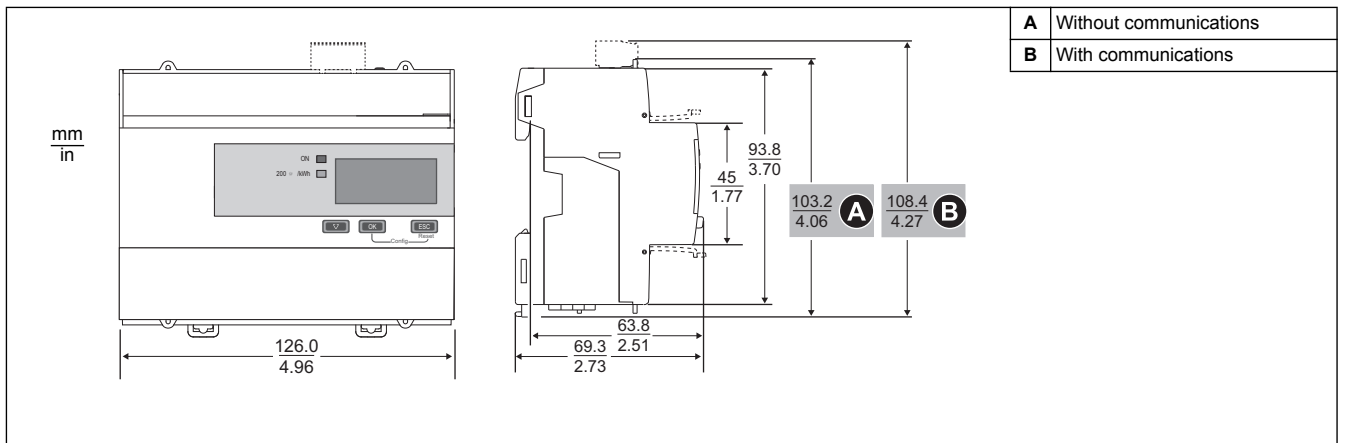

Hardware overview

All meters: Meter sealing points

All meters have sealing covers and sealing points to help prevent access to inputs and outputs and current and voltage connections.

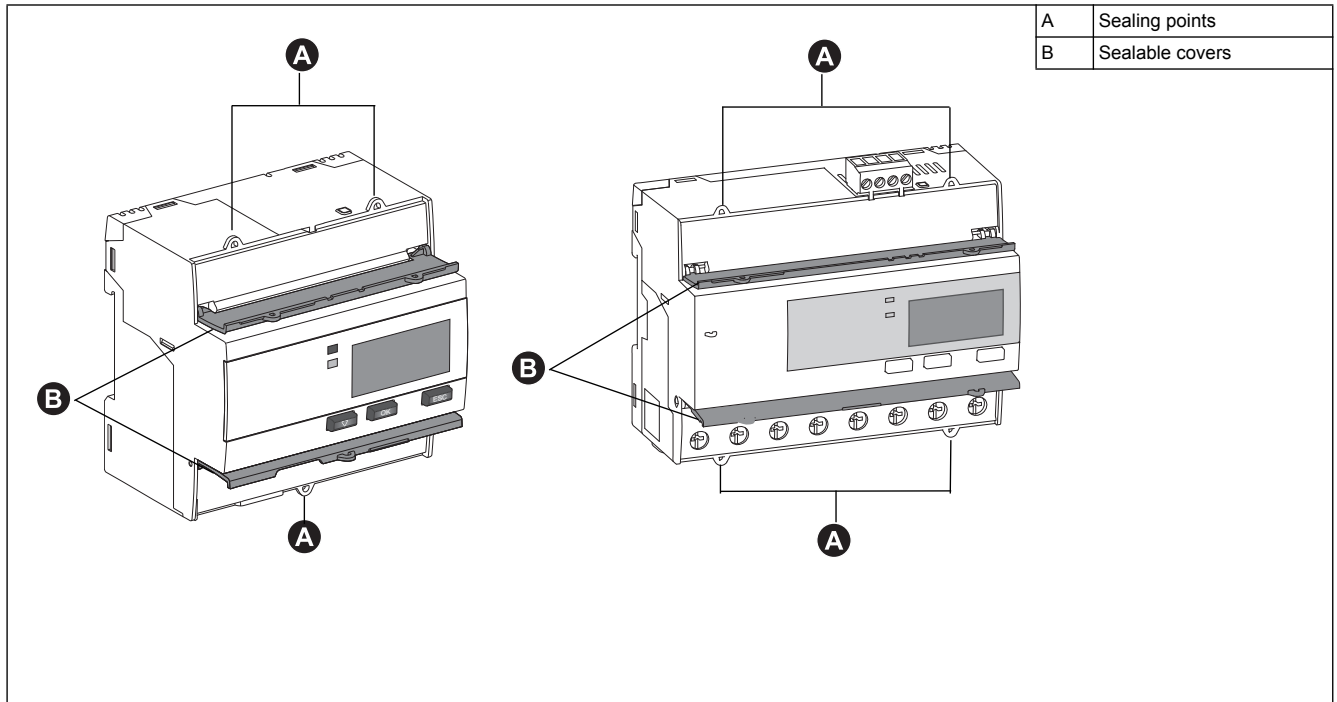

iEM3100 / iEM3110 / iEM3115 - Direct measurement up to 63 A

The various features of the iEM3100 / iEM3110 / iEM3115 are shown in the diagram below:

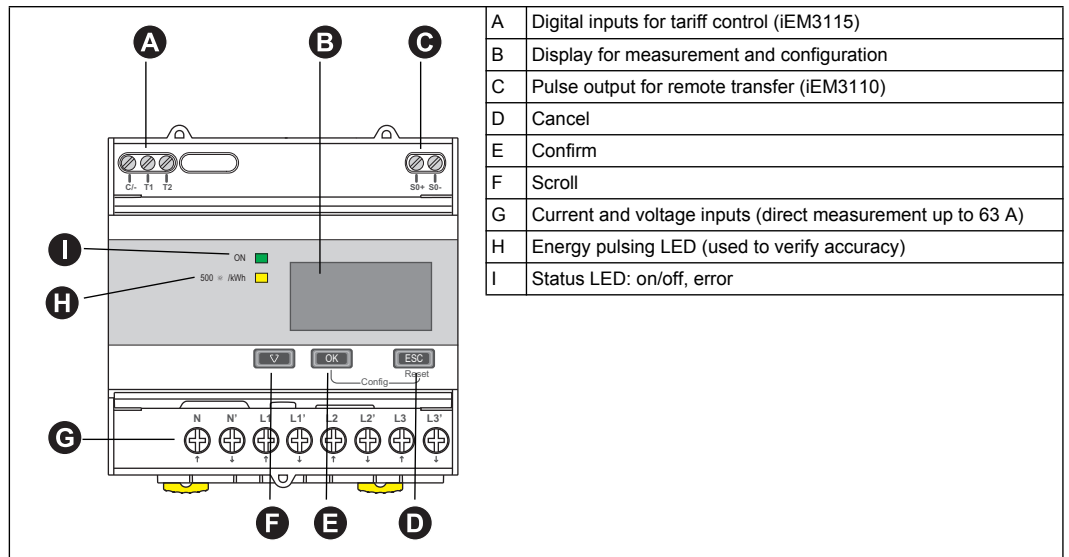

iEM3135 - Direct measurement up to 63 A and M-Bus communications

The various features of the iEM3135 are shown in the diagram below:

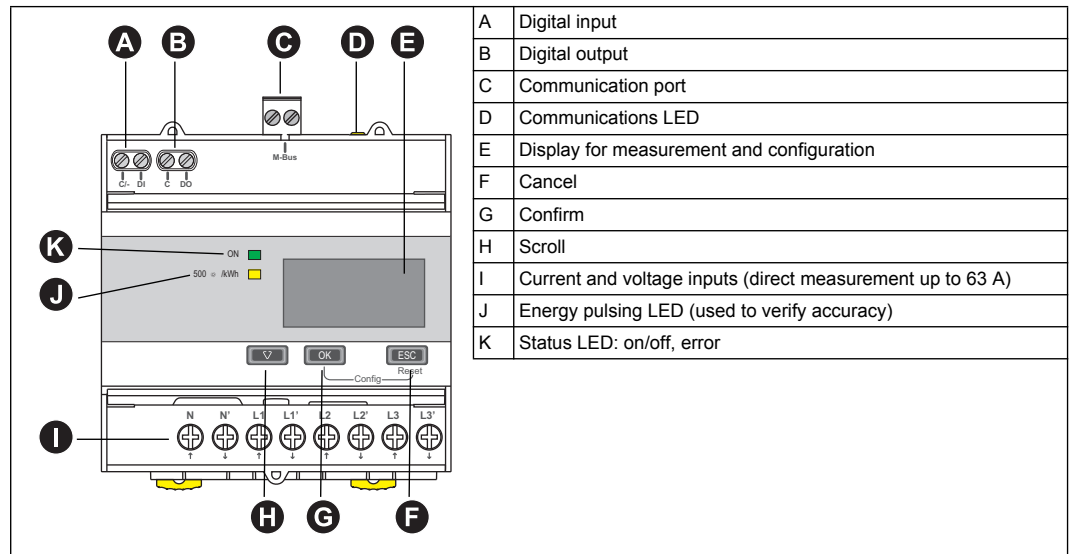

iEM3150 / iEM3155 / iEM3165 - Direct measurement up to 63 A and Modbus or BACnet communications

The various features of the iEM3150 / iEM3155 / iEM3165 are shown in the diagram below:

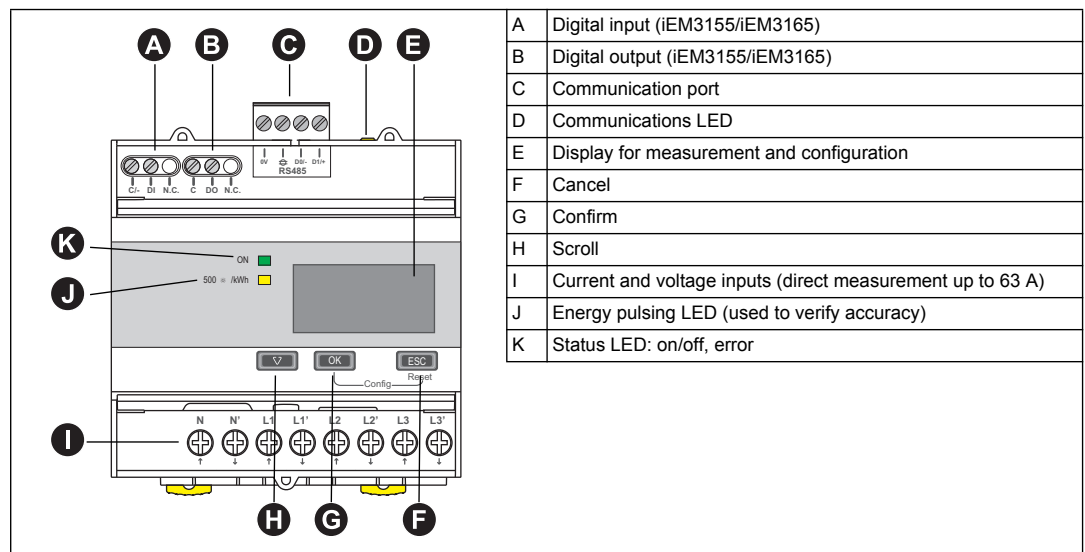

iEM3175 - Direct measurement up to 63 A and LonWorks communications

The various features of the iEM3175 are shown in the diagram below:

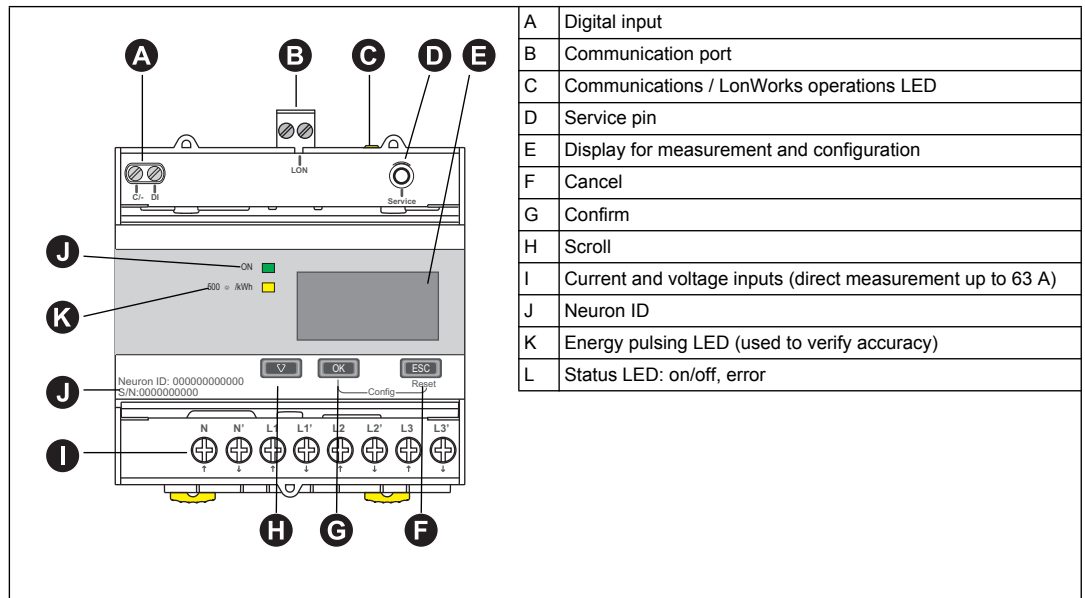

iEM3200 / iEM3210 / iEM3215 - Measurement with CTs

The various features of the listed meters (CTs 1 A or 5 A) are shown in the diagram below:

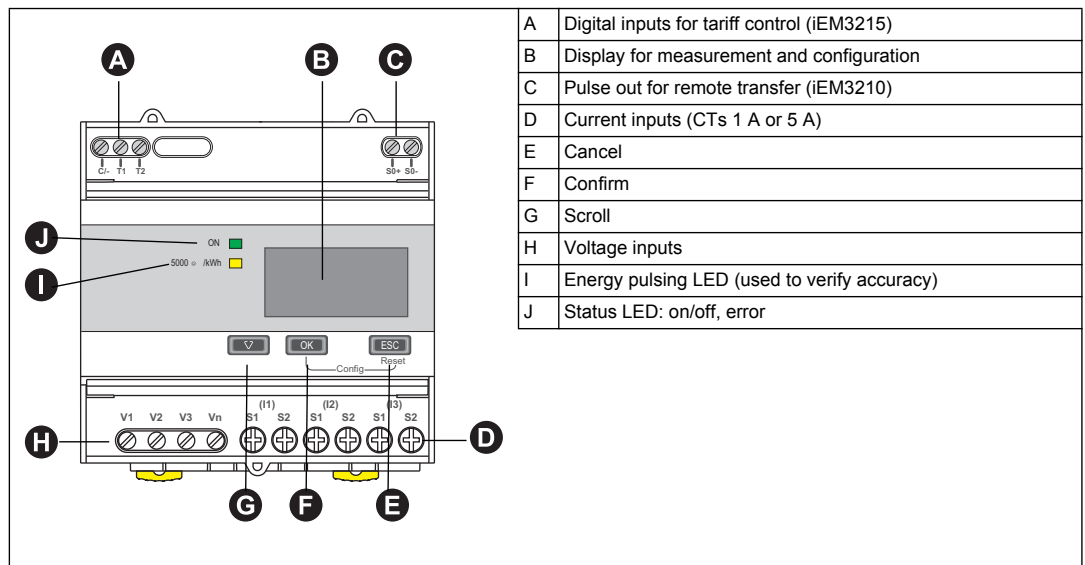

iEM3235 - Measurement with CTs and M-Bus communications

The various features of the iEM3235 (CTs 1 A or 5 A with M-Bus communications) are shown in the diagram below:

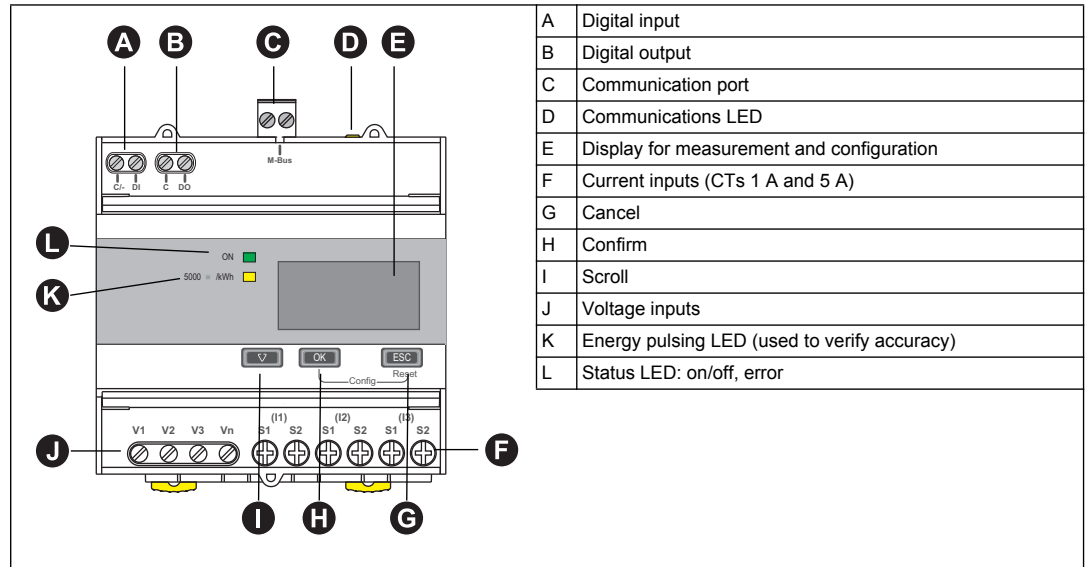

iEM3250 / iEM3255 / iEM3265 - Measurement with CTs and Modbus or BACnet communications

The various features of the iEM3250 / iEM3255 / iEM3265 (CTs 1 A or 5 A with Modbus or BACnet communication) are shown in the diagram below:

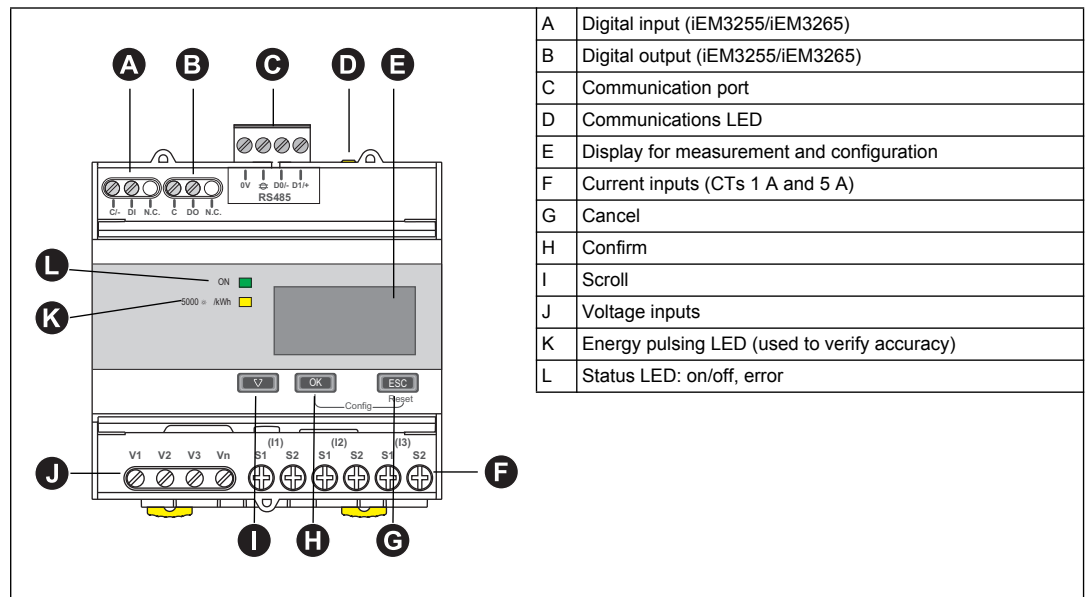

iEM3275 - Measurement with CTs and LonWorks communications

The various features of the iEM3275 (CTs 1 A or 5 A with LonWorks communications) are shown in the diagram below:

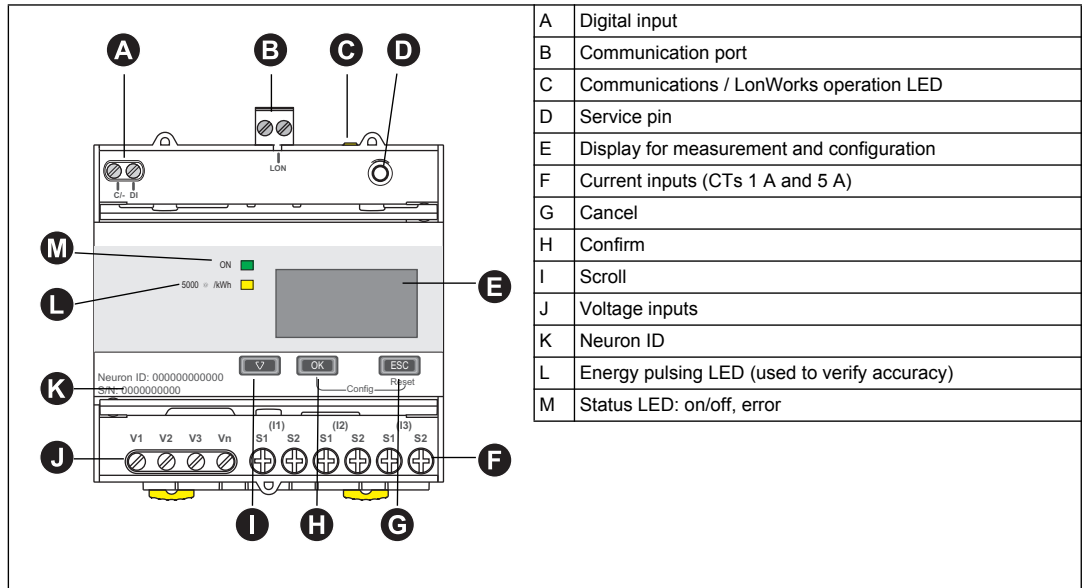

iEM3300 / iEM3310 - Direct measurement up to 125 A

The various features of the iEM3300 / iEM3310 are shown in the diagram below:

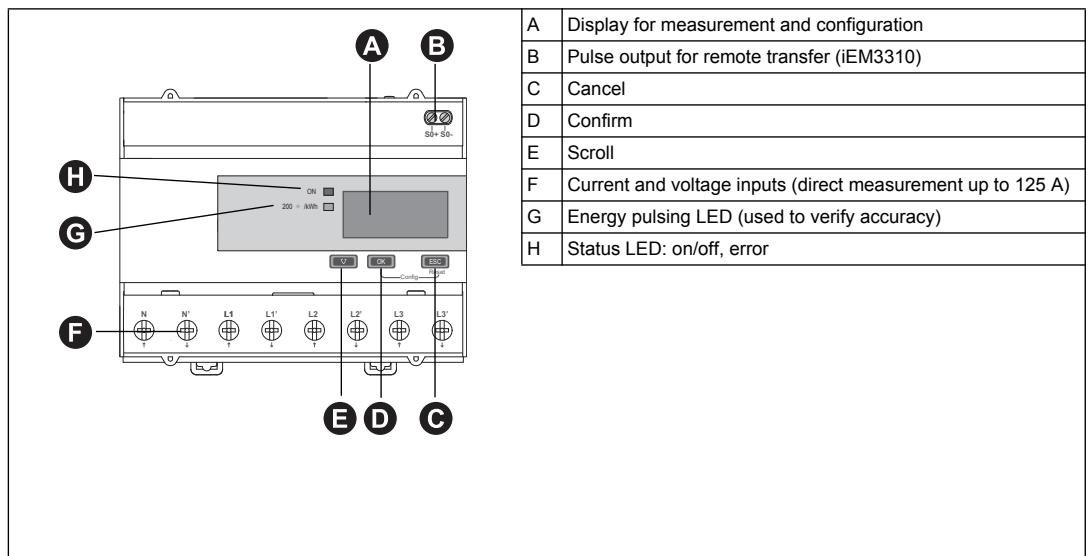

iEM3335 - Direct measurement up to 125 A and M-Bus communications

The various features of the iEM3335 are shown in the diagram below:

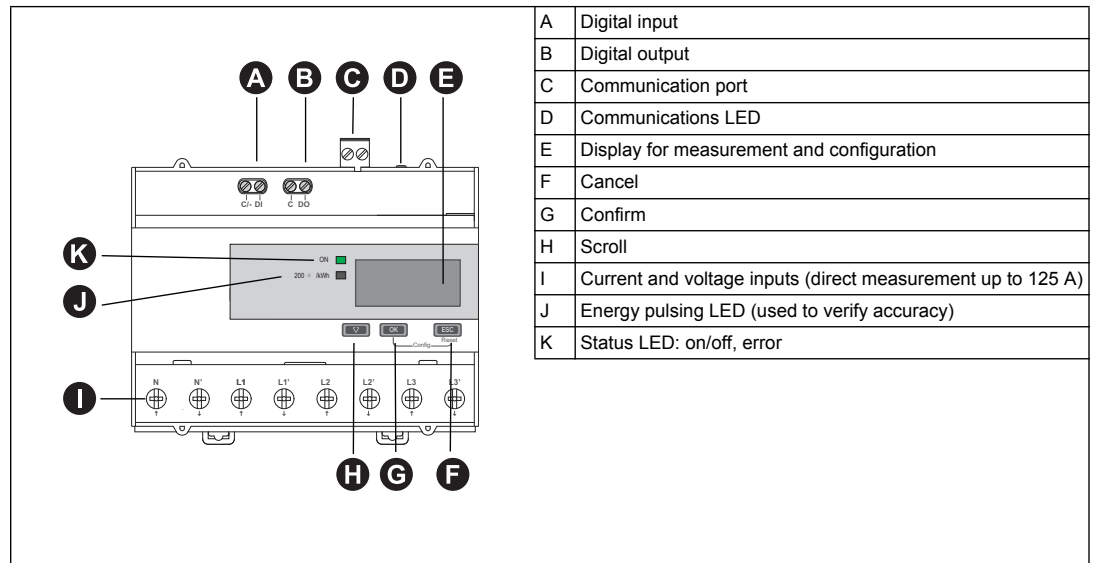

iEM3350 / iEM3355 / iEM3365 - Direct measurement up to 125 A and Modbus or BACnet communications

The various features of the iEM3350 / iEM3355 / iEM3365 are shown in the diagram below:

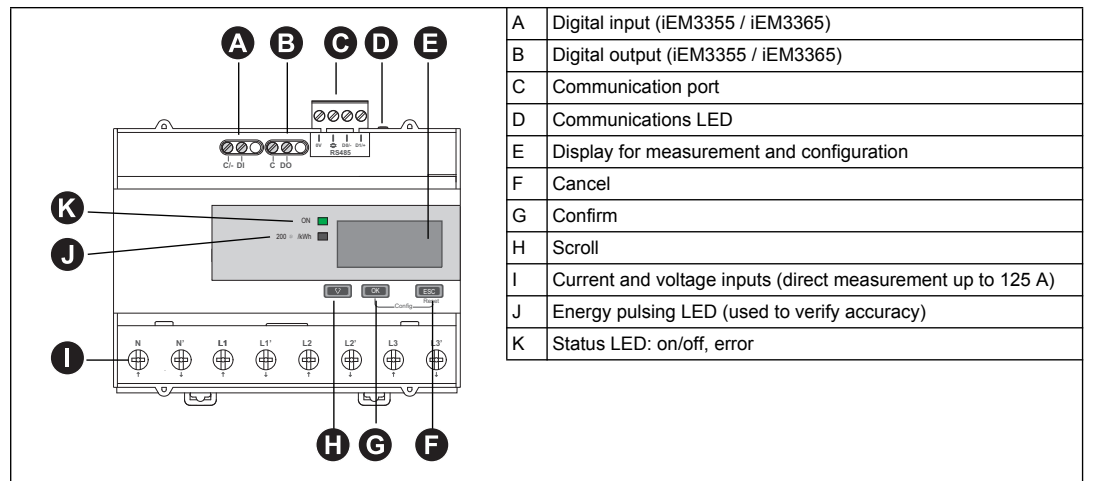

iEM3375 - Direct measurement up to 125 A and LonWorks communications

The various features of the iEM3375 are shown in the diagram below:

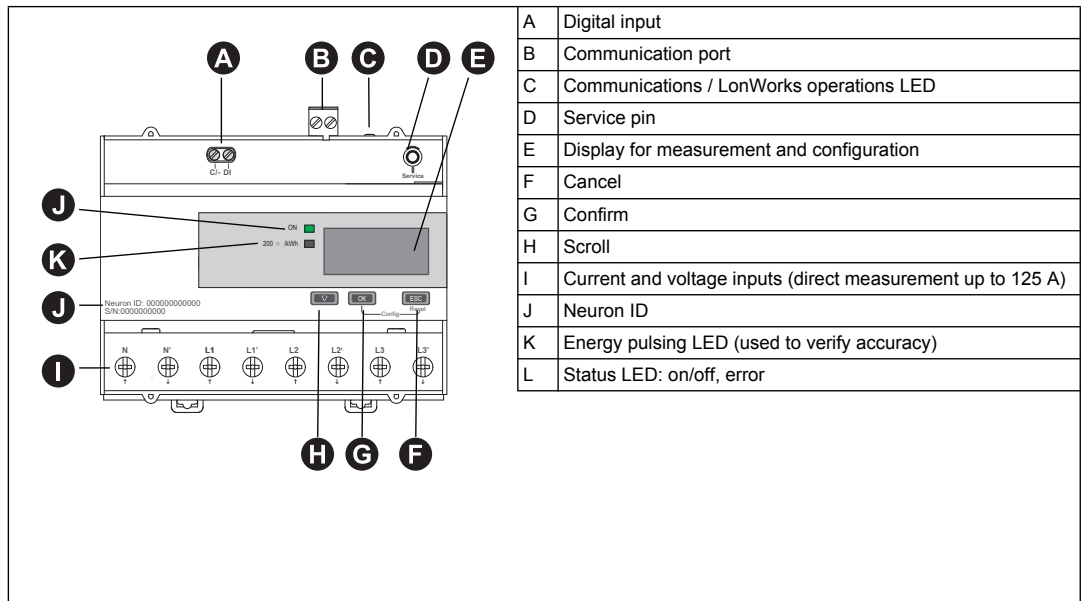

DIN rail mounting and dismounting

⚠ DANGER

HAZARD OF ELECTRIC SHOCK, EXPLOSION, OR ARC FLASH

- Apply appropriate personal protective equipment (PPE) and follow safe electrical work practices. See NFPA 70E in the USA or applicable local standards.
- This equipment must only be installed and serviced by qualified electrical personnel.
- Turn off all power supplying this device and the equipment in which it is installed before working on the device or equipment.
- Always use a properly rated voltage sensing device to confirm power is off.
- Replace all devices, doors and covers before turning on power to this equipment.
- Do not exceed the device's ratings for maximum limits.

Failure to follow these instructions will result in death or serious injury.

Mounting the meter on a DIN rail

1. Position the 2 upper slots on the rear of the meter onto the DIN rail.

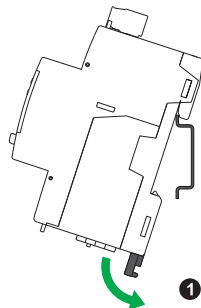

2. Press the meter against the DIN rail until the locking mechanism engages. The meter is now attached to the rail. Make sure that the device is not tilted following installation.

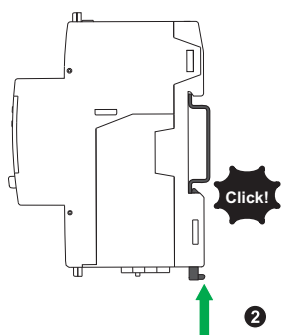

Dismounting the meter from a DIN rail

1. Use a flat-tip screwdriver (≤ 6.5 mm / 0.25 in) to lower the locking mechanism and release the meter.

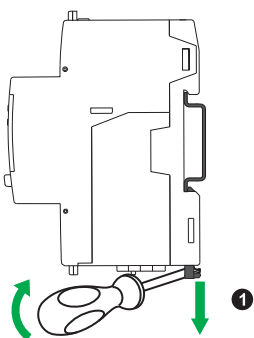

2. Lift the meter out and up to free it from the DIN rail.

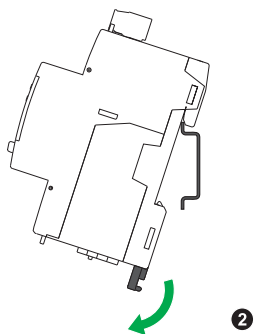

Input, output and communications wiring

This section describes the wiring of the digital inputs, digital and pulse outputs and the communications (as applicable).

⚠ DANGER

HAZARD OF ELECTRIC SHOCK, EXPLOSION, OR ARC FLASH

- Apply appropriate personal protective equipment (PPE) and follow safe electrical work practices. See NFPA 70E in the USA or applicable local standards.
- This equipment must only be installed and serviced by qualified electrical personnel.
- Turn off all power supplying this device and the equipment in which it is installed before working on the device or equipment.
- Always use a properly rated voltage sensing device to confirm power is off.
- Replace all devices, doors and covers before turning on power to this equipment.
- Do not exceed the device's ratings for maximum limits.

Failure to follow these instructions will result in death or serious injury.

⚠ WARNING

UNINTENDED OPERATION

Do not use the meter for critical control or protection applications where human or equipment safety relies on the operation of the control circuit.

Failure to follow these instructions can result in death, serious injury or equipment damage.

Related topics

- See "Power system wiring" on page 26 for information on wiring the voltage and current connections.

Pulse output wiring: iEM3110 / iEM3210 / iEM3310

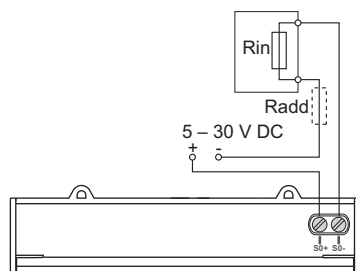

- The pulse output is compatible with S0 format.
- The pulse output can be directly connected to a 24 V DC (< 30 V DC) input on a Zelio or Twido PLC.
- The pulse output indicates the primary consumption with consideration of transformer ratios.
- For other concentrators, if $V_{DC}/R_{in} > 15 \text{ mA}$, add a resistor $R_{add} = (V_{DC}/0.01) - R_{in} \Omega$

Digital input wiring: iEM3115 / iEM3215

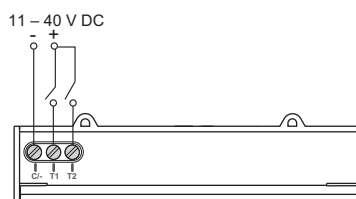

Digital input wiring: iEM3135 / iEM3155 / iEM3165 / iEM3175 / iEM3235 / iEM3255 / iEM3265 / iEM3275 / iEM3335 / iEM3355 / iEM3365 / iEM3375

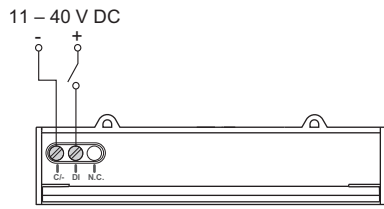

- The digital input and output are electrically independent.

Digital output wiring: iEM3135 / iEM3155 / iEM3165 / iEM3235 / iEM3255 / iEM3265 / iEM3335 / iEM3355 / iEM3365

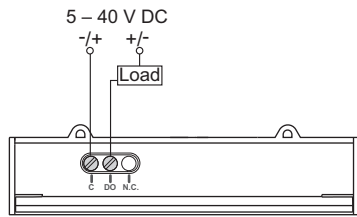

- The programmable digital output is compatible with S0 format when configured as a pulse output.
- The digital output is polarity-independent.
- The digital input and output are electrically independent.

Modbus RS-485 communications wiring: iEM3150 / iEM3155 / iEM3250 / iEM3255 / iEM3350 / iEM3355

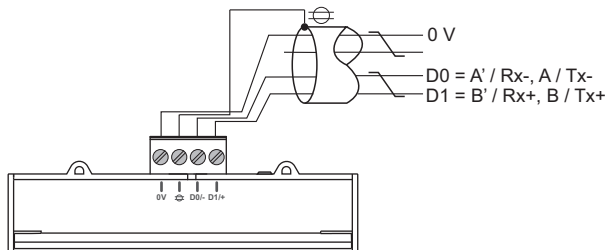

BACnet RS-485 communications wiring: iEM3165 / iEM3265 / iEM3365

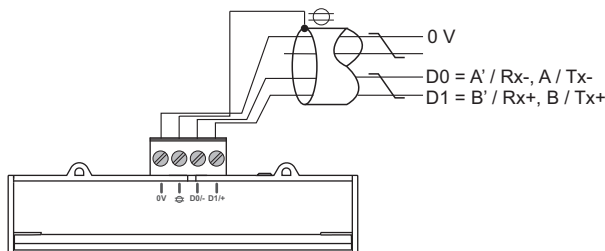

M-Bus communications wiring: iEM3135 / iEM3235 / iEM3335

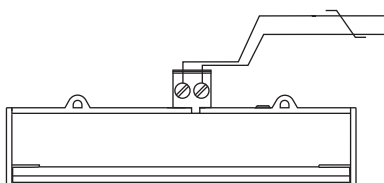

- The M-Bus communications connection is polarity-independent.

LonWorks communications wiring: iEM3175 / iEM3275 / iEM3375

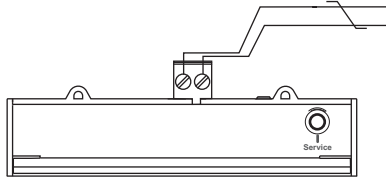

- The LON communications connection is polarity-independent.

Power system wiring

The diagrams below illustrate how to connect the meters to a single-phase or three-phase 3-wire or 4-wire power system.

⚠ DANGER

HAZARD OF ELECTRIC SHOCK, EXPLOSION, OR ARC FLASH

- Apply appropriate personal protective equipment (PPE) and follow safe electrical work practices. See NFPA 70E in the USA or applicable local standards.
- This equipment must only be installed and serviced by qualified electrical personnel.
- Turn off all power supplying this device and the equipment in which it is installed before working on the device or equipment.
- Always use a properly rated voltage sensing device to confirm power is off.
- Replace all devices, doors and covers before turning on power to this equipment.
- Do not exceed the device's ratings for maximum limits.

Failure to follow these instructions will result in death or serious injury.

Voltage input protection

The meter's voltage inputs must be wired to fuses/breakers and a disconnect switch. If using a voltage transformer (VT), both primary and secondary sides of the VT must be fused and switched.

- Clearly label the device's disconnect circuit mechanism and install it within easy reach of the operator.
- Fuses / circuit breakers must be:
 - installed in accordance with all local and national electrical codes and standards, and
 - rated for the installation voltage, available fault current, and sized for connected loads.
- Fuse for neutral is required if the source neutral connection is not grounded.

Current input protection for 1 A and 5 A meters

For all connected current inputs on 1 A and 5 A meters with external CTs, use a CT shorting block to short-circuit the secondary leads of the CTs before removing the current input connections to the meter.

NOTE: Ground any unused current inputs on 1 A and 5 A meters.

iEM31•• and iEM33•• devices associated with a contactor

Connection requirements for iEM3100 / iEM3110 / iEM3115 / iEM3135 / iEM3150 / iEM3155 / iEM3165 / iEM3175 / iEM3300 / iEM3310 / iEM3335 / iEM3350 / iEM3355 / iEM3365 / iEM3375:

- When the meter is associated with a contactor, connect the meter upstream of the contactor.
- The meter must be protected by a circuit breaker.

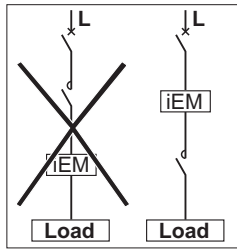

Related topics

- See “Input, output and communications wiring” on page 24 for information on wiring the digital inputs, digital or pulse outputs and communications for your device.

63 A direct measurement meter wiring

⚠ DANGER

HAZARD OF ELECTRIC SHOCK, EXPLOSION, OR ARC FLASH

- Do not allow the total additive current flowing through the device to exceed 63 A.

Failure to follow these instructions will result in death or serious injury.

A Fuses and disconnect switch

Power system	Wiring
1PH2W L-N	<p style="text-align: center;">≤277 V L-N</p>
1PH2W L-L	<p style="text-align: center;">≤480 V L-L</p>
1PH3W L-L-N	<p style="text-align: center;">≤277 V L-N ≤480 V L-L</p>
3PH3W	<p style="text-align: center;">≤480 V L-L</p>
3PH4W	<p style="text-align: center;">≤277 V L-N ≤480 V L-L</p>

⚠ DANGER

HAZARD OF ELECTRIC SHOCK, EXPLOSION, OR ARC FLASH

- Do not connect N' to the load when setting the wiring type on the meter to 1PH4W Multi L-N.

Failure to follow these instructions will result in death or serious injury.

Power system	Wiring
1PH multiple loads with neutral (1PH4W Multi L-N) ¹	
<p>¹The 1PH4W Multi L-N wiring type is only available on the iEM3135, iEM3150, iEM3155, iEM3165 and iEM3175.</p>	

125 A direct measurement meter wiring

⚠ DANGER

HAZARD OF ELECTRIC SHOCK, EXPLOSION, OR ARC FLASH

- Do not allow the total additive current flowing through the device to exceed 125 A.

Failure to follow these instructions will result in death or serious injury.

A Fuses and disconnect switch

Power system	Wiring
1PH2W L-N	
1PH2W L-L	
1PH3W L-L-N	
3PH3W	

Power system	Wiring	
3PH4W		

⚠ DANGER

HAZARD OF ELECTRIC SHOCK, EXPLOSION, OR ARC FLASH

- Do not connect N' to the load when setting the wiring type on the meter to 1PH4W Multi L-N.

Failure to follow these instructions will result in death or serious injury.

Power system	Wiring
1PH multiple loads with neutral (1PH4W Multi L-N) ¹	
<p>¹The 1PH4W Multi L-N wiring type is only available on the iEM3335, iEM3350, iEM3355, iEM3365 and iEM3375.</p>	

5 A / 1 A meter wiring

⚠ DANGER

HAZARD OF ELECTRIC SHOCK, EXPLOSION, OR ARC FLASH

- Never short the secondary of a voltage transformer (VT).
- Never open circuit a current transformer (CT); use the shorting block to short circuit the leads of the CT before removing the connection from the meter.
- Always use grounded external CTs for current inputs.

Failure to follow these instructions will result in death or serious injury.

Single-phase systems with CTs

- A** 250 mA fuses and disconnect switch
- B** Shorting block

Power system	Wiring
1PH2W L-N	

Power system	Wiring	
1PH2W L-L		
1PH3W L-L-N		
1PH multiple loads with neutral (1PH4W Multi L-N) ¹	2CTs	3CTs

¹The 1PH4W Multi L-N wiring type is only available on the iEM3235, iEM3250, iEM3255, iEM3265 and iEM3275

Three-phase systems with CTs

- A** 250 mA fuses and disconnect switch
- B** Shorting block
- ♦ indicates wiring for a balanced system

Power system	Wiring		
3PH3W	1 CT ♦	2CTs	3CTs
3PH4W	1 CT ♦	2 CTs ♦	3CTs

Three-phase systems with CTs and VTs

- A** 250 mA fuses and disconnect switch
 - B** Shorting block
 - C** VT primary fuses and disconnect switch
- ♦ indicates wiring for a balanced system

Power system	Wiring		
3PH3W	2 VTs, 1 CT ♦	2 VTs, 2 CTs	2 VTs, 3 CTs
	3PH4W	3 VTs, 1 CTs ♦	3 VTs, 2 CTs ♦

Chapter 4 Front panel display and meter setup

What is in this chapter?

This chapter contains the following topics:

- Overview** 33
- Data display** 33
- Resets** 36
- Multi Tariff feature** 36
- Meter status information** 37
- The device clock** 37
- Device configuration** 38
- Modifying parameters** 39
- Configuration mode menus** 40

Overview

The meter features a front panel with signaling LEDs, a graphical display, and menu buttons that allow you to access the information required to operate the meter and modify parameter settings.

The front panel also allows you to display, configure and reset parameters.

Some meters have the Multi Tariff feature, which allows you to configure different tariffs.

Data display

Data display screen overview

A	Measurement
B	Ea / Er = active / reactive energy (if available)
C	Value
D	Active tariff (if applicable)
E	Scroll through the available screens
F	View more screens related to the measurement category (if available)
G	Go back to previous screen
H	Date and time (if applicable)
I	Unit

Example: navigating the display screens

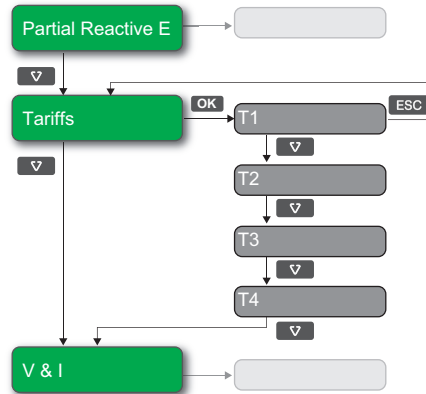

1. Press **▼** to scroll through the main display screens; in the image above, press **▼** to move from **Partial Reactive E** to **Tariffs** to **V & I**.
2. Press **OK** to access additional screens related to main screen (if available); in the image above, press **OK** to access screens for each of the available tariffs.
3. Press **▼** to scroll through these additional screens.

Related topics

- See “Data display screens” on page 34 for information on the screens available on each meter model.

Data display screens

The following sections outline the data display screens available on the various meter models.

Data display screens: iEM3100 / iEM3110 / iEM3115 / iEM3200 / iEM3210 / iEM3215 / iEM3300 / iEM3310

	A	Resets all energy measurements except total active energy
	B	iEM3115 / iEM3215
	C	Diagnosis screen appears if there is a specific event

Related topics

- See “Troubleshooting” on page 103 for more information on the Diagnosis screen and a list of diagnostic codes.
- See “Resets” on page 36 for more information on meter resets.

Data display screens: iEM3150 / iEM3250 / iEM3350

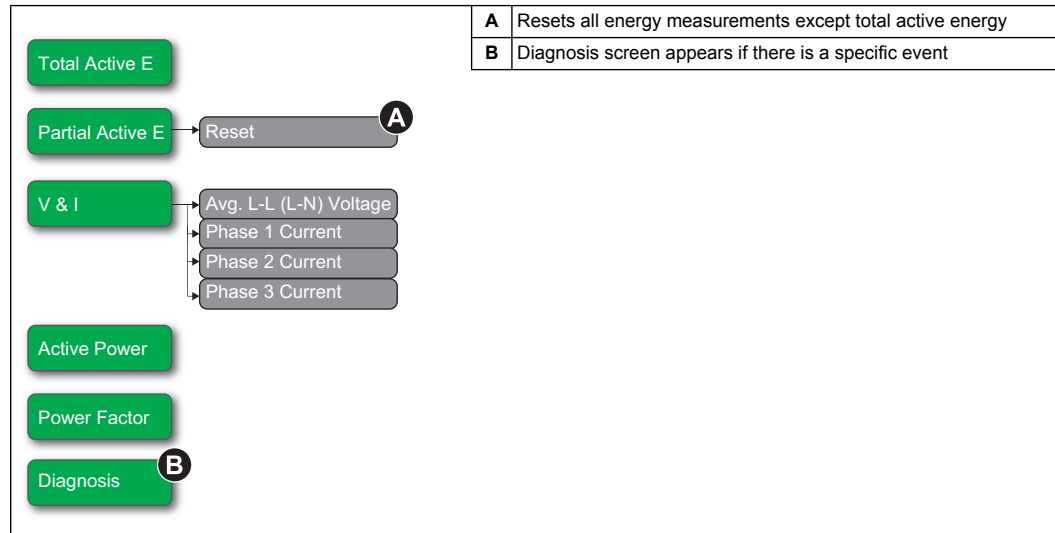

Related topics

- See “Troubleshooting” on page 103 for more information on the Diagnosis screen and a list of diagnostic codes.
- See “Resets” on page 36 for more information on meter resets.

Data display screens: iEM3135 / iEM3155 / iEM3165 / iEM3175 / iEM3235 / iEM3255 / iEM3265 / iEM3275 / iEM3335 / iEM3355 / iEM3365 / iEM3375

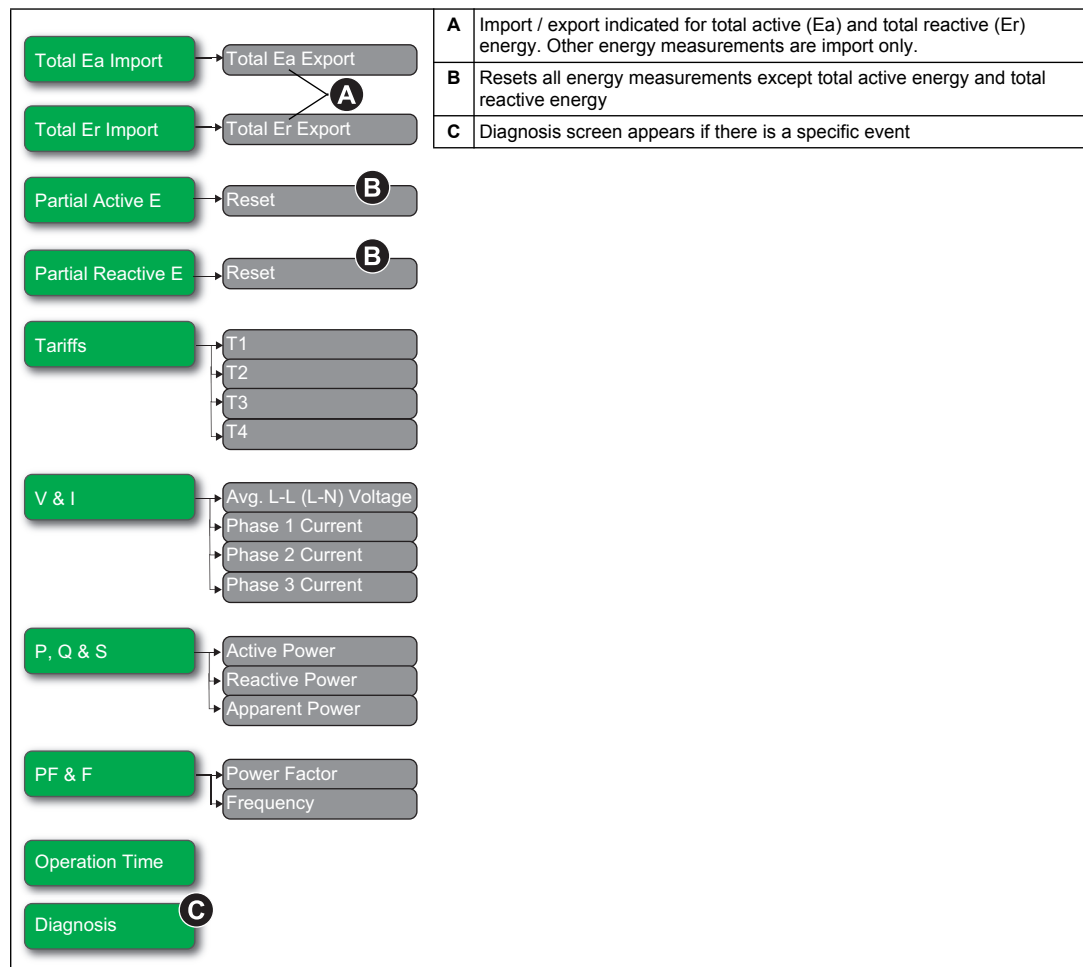

Related topics

- See “Troubleshooting” on page 103 for more information on the Diagnosis screen and a list of diagnostic codes.
- See “Resets” on page 36 for more information on meter resets.

Resets

The following resets are available, depending on your meter model:

Reset	Description
Partial energy	Clears all active and reactive energy accumulated since the last reset. NOTE: this does not reset the total active and reactive energy accumulation.
Input metering	Clears all input metering energy data. NOTE: you can only reset the input metering accumulation using software.

Resetting accumulated energy using the display

1. Navigate to the **Partial Active E** or **Partial Reactive E** screen. The screen displays the date of the last reset. For example:

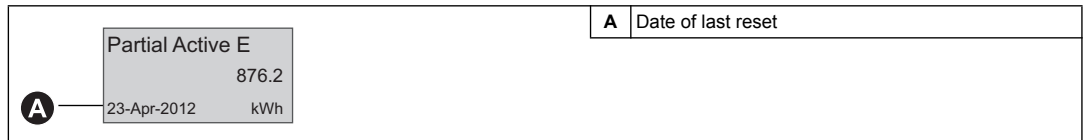

2. Press and hold **ESC**. The **Reset** screen appears.
3. Press **OK** to confirm the reset and enter the meter password when prompted.
NOTE: Regardless of the screen you use to access this reset, accumulations of both Partial Active Energy and the Partial Reactive Energy (if available) are cleared.

Related topics

- See your software documentation for information on resetting the input metering accumulation.

Multi Tariff feature

The Multi Tariff feature is available on the following devices: iEM3115, iEM3135, iEM3155, iEM3165, iEM3175, iEM3215, iEM3235, iEM3255, iEM3265, iEM3275, iEM3335, iEM3355, iEM3365 and iEM3375.

The following table illustrates how the tariffs operate according to the tariff selection (2, 3 or 4 tariffs). These tariffs are stored in 4 different registers: T1, T2, T3 and T4.



	2 tariffs	3 tariffs	4 tariffs
Weekday			
Weekend			











NOTE: If the tariff Control Mode is set to by Internal Clock, the start time of the next tariff is the end time of the current tariff. For example, T2 start equals the end of T1.

Meter status information

Two LEDs on the front panel indicate the current status of the device: the green status LED and the yellow energy pulsing LED.

The icons in the table below indicate the LED state as follows:

-  = LED is off
-  = LED is on
-  = LED is flashing

Status LED	Energy pulsing LED	Description
		Off
	 1s > 	On, no pulse counting
		On, with pulse counting
		Error, pulse counting stopped
		Abnormal, with pulse counting

Related topics

See the section for the protocol of your device for information on the communication LED:

- “Troubleshooting” on page 103
- “Communications LED indicator for Modbus devices” on page 51
- “LED indicators for LonWorks meters” on page 63
- “Communications LED indicator for M-Bus meters” on page 76
- “Communications via BACnet” on page 89

The device clock

This section does not apply to the iEM3100, iEM3200 or iEM3300.

You must reset the time to account for any time change (for example, to switch the time from standard time to daylight savings time).

Clock behavior on power interruption

iEM3110, iEM3150, iEM3210, iEM3250, iEM3310 and iEM3350: When power is interrupted, the date and time are reset. When power is restored, the device automatically displays the screen to set **Date and Time**.

iEM3115, iEM3135, iEM3155, iEM3165, iEM3175, iEM3215, iEM3235, iEM3255, iEM3265, iEM3275, iEM3335, iEM3355, iEM3365 and iEM3375: When the power is interrupted, the device retains its date and time information for 3 days. If power is interrupted for longer than 3 days, the device automatically displays the screen to set **Date and Time** when power is restored.

Date/time format

The date is displayed in the following format: DD-MMM-YYYY.

The time is displayed using the 24-hour clock in the following format: hh:mm:ss.

Setting the clock initially

The following diagram illustrates how to set the clock when you initially power up the device or after a power failure. To set the clock during normal operation, see the section on device configuration.

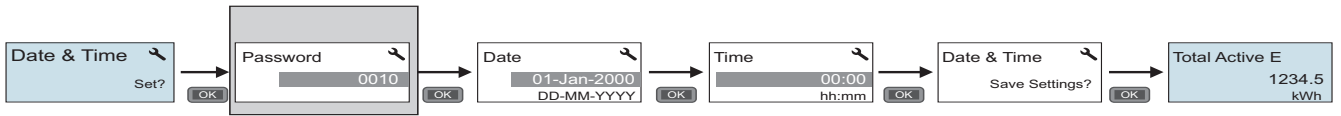

NOTE: Password entry is only required for meters that support a password.

Related topics

- See “Device configuration” on page 38 for information on setting the clock during normal device operation.

Device configuration

The default factory settings are listed in the following table:

Menu	Factory settings
Wiring	iEM31*: 3PH4W iEM32*: 3PH4W; 3 CTs on I1, I2, and I3; Direct-No VT iEM33*: 3PH4W
CT Ratio	CT Secondary = 5 A; CT Primary = 5 A
CT & VT Ratio	CT Secondary = 5 A; CT Primary = 5 A VT Secondary = 100 V; VT Primary = 100 V
Frequency	50 Hz
Date	1-Jan-2000
Time	00:00:00
Multi Tariffs	Disable
Overload Alarm	Disable
Digital Output	Disable
Digital Input	Input Status
Pulse Output	100 imp / kWh
Communication	Varies depending on protocol
Com.Protection	Enable
Contrast	5
Password	0010

Entering configuration mode

1. Press and hold **OK** and **ESC** at the same time for about 2 seconds.
2. Enter the meter password, if prompted. The **Access Counter** screen displays, indicating the number of times the configuration mode has been accessed.

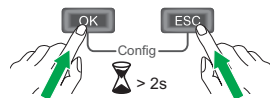

The front panel display in configuration mode

The diagram below illustrates the various elements of the display in configuration mode:

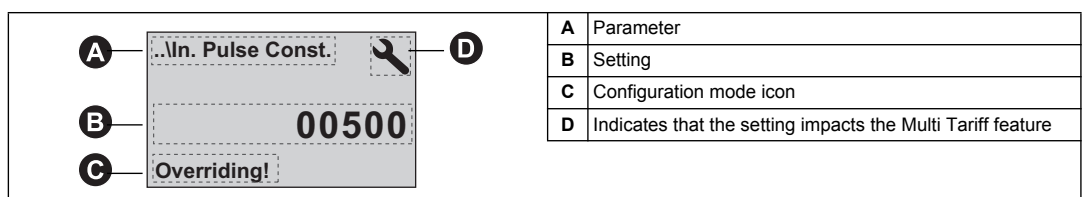

Related topics

- See “Modifying parameters” on page 39 for instructions on using the front panel buttons to configure list and numeric value settings.
- See “Configuration mode menus” on page 40 for a diagram of your device’s configuration screens.

Com. Protection setting

For meters with communications capabilities, you can enable or disable the Com. Protection setting. If this setting is enabled, you must use the display to configure certain settings (for example, wiring or frequency, etc.) and perform resets; you cannot use communications.

The protected settings and resets are:

- Power system settings (for example, wiring, frequency, CT ratios)
- Date and time settings
- Multi-tariff settings
- Communications settings
- Partial energy reset

Modifying parameters

There are two methods for modifying a parameter, depending on the type of parameter:

- selecting a value in a list (for example, selecting 1PH2W L-N from a list of available power systems), or
- modifying a numerical value, digit by digit (for example, entering a value for the date, time or VT primary).

NOTE: Before you modify any parameters, ensure that you are familiar with the HMI functionality and navigation structure of your device in configuration mode.

Related topics

- See “Configuration mode menus” on page 40 for information on navigating the configuration menus on your device.

Selecting a value from a list

1. Use the down button to scroll through the parameter values until you reach the desired value.
2. Press **OK** to confirm the new parameter value.

Example: Configuring a list value

To set the nominal frequency of the meter:

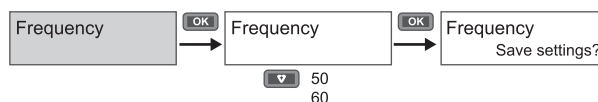

1. Enter configuration mode and press the down button until you reach **Frequency** then press **OK** to access the frequency configuration.
2. Press the down button to select the frequency you want then click **OK**. Press **OK** again to save your changes.

Modifying a numerical value

When you modify a numerical value, the digit on the far right side is selected by default (except for Date/Time).

The parameters listed below are the only ones for which you set a numerical value (if the parameter is available on your device):

- Date
- Time
- Pick Up Value for an overload alarm
- Voltage Transformer (VT) Primary
- Current Transformer (CT) Primary
- Password
- Address of the meter

To modify a numerical value:

1. Use the down button to modify the selected digit.
2. Press **OK** to shift to next digit. Modify the next digit, if needed, or press okay to move to the next digit. Continue to move through the digits until you reach the last digit then press **OK** again to confirm the new parameter value.

If you enter an invalid setting for the parameter, when you press **OK** after setting the left-most number, the cursor shifts back to the right-most number so you can enter a valid value.

Example: configuring a numeric value

To set the password:

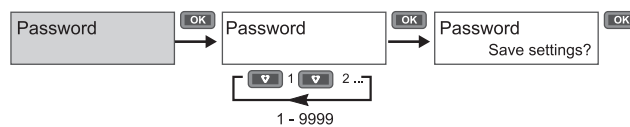

1. Enter configuration mode and press the down button until you reach **Password** then press **OK** to access the password configuration.
2. Press the down button to increment the selected digit or press **OK** to move to the next digit to the left. When you reach the left-most digit, press **OK** to move to the next screen. Press **OK** again to save your changes.

Canceling an entry

To cancel the current entry, press the **ESC** button . The change is canceled and the screen reverts to the previous display.

Configuration mode menus

The diagrams below show the configuration navigation for each device.

Related topics

- See “Modifying parameters” on page 39 for instructions on how to change settings.

Configuration menu for iEM3100 / iEM3110 / iEM3115 / iEM3300 / iEM3310

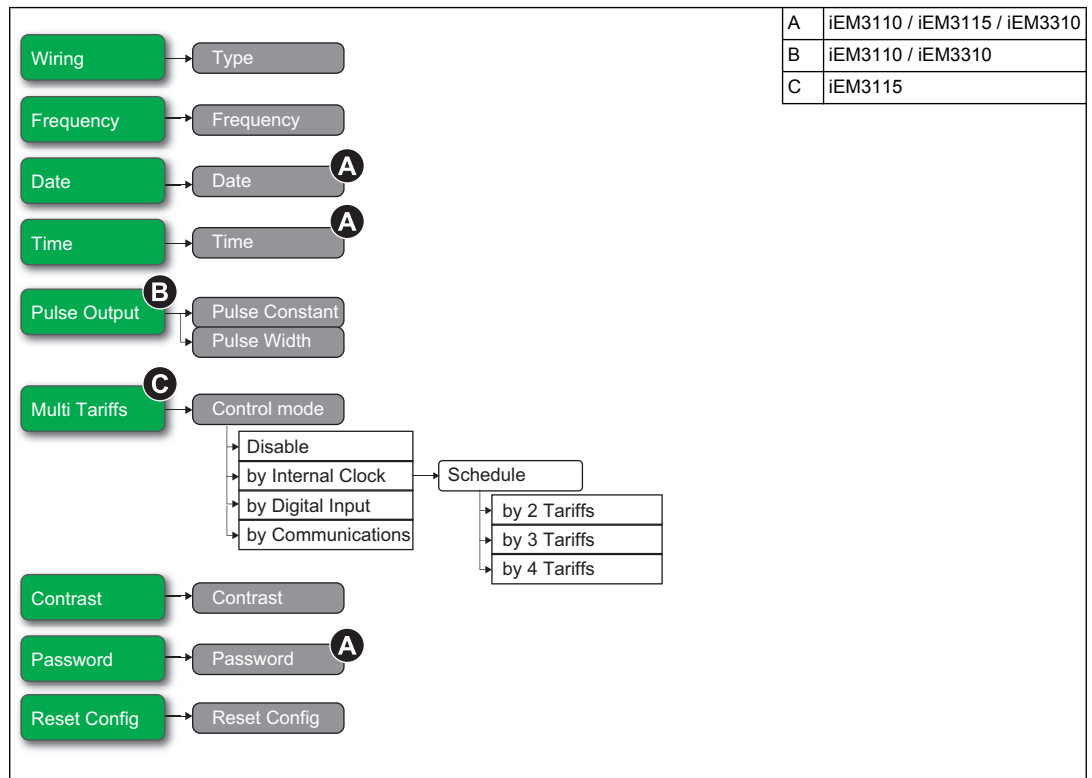

Section	Parameter	Options	Description
Wiring	Type	3PH3W 3PH4W 1PH2W L-N 1PH2W L-L 1PH3W L-L-N	Select the power system type the meter is wired to.
Frequency	Frequency	50 60	Select the frequency of the electrical power system, in Hz.
Date (iEM3110 / iEM3115 / iEM3310)	Date	DD-MMM-YYYY	Set the current date using the specified format.
Time (iEM3110 / iEM3115 / iEM3310)	Time	hh:mm	Use the 24-hour format to set the time.
Pulse Output	Pulse Constant (imp/kWh)	100 200 1000 1 10 20	Set the pulses per kWh for the pulse output.
	Pulse Width (ms)	50 100 200 300	Set the pulse width (ON time).
Multi Tariffs (iEM3115)	Control Mode	Disable by Digital Input by Internal Clock	Select the tariff control mode: <ul style="list-style-type: none"> Disable: the Multi Tariff function is disabled. by Digital Input: the digital input is associated with the multi-tariff function. A signal to the digital input changes the active tariff. by Internal Clock: the device clock controls the active tariff. If you set the Control Mode to by Internal Clock, you must also configure the schedule. Set the time when each tariff period starts, using the 24 hour clock format (00:00 to 23:59). The start time of the next tariff is the end time of the current tariff. For example, T2 start equals the end of T1.
Contrast	Contrast	1-9	Increase or decrease the value to increase or decrease the display contrast.
Password (iEM3110 / iEM3115 / iEM3310)	Password	0-9999	Sets the password for accessing the meter configuration screens and resets.
Reset Config	Reset Config	—	Settings are reset to their defaults, except for Password. Meter restarts.

Configuration menu for iEM3150 / iEM3350

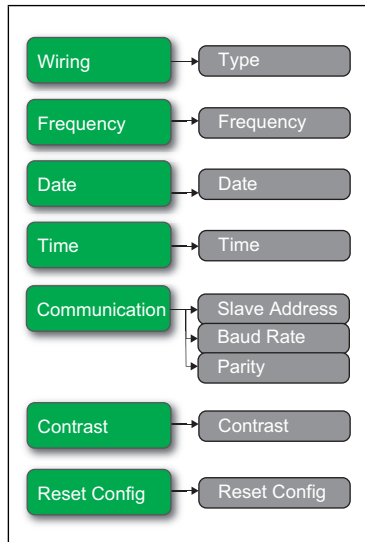

Section	Parameter	Options	Description
Wiring	Type	3PH4W 1PH2W L-N 1PH2W L-L 1PH3W L-L-N 3PH3W 1PH4W Multi L-N	Select the power system type the meter is wired to.
Frequency	Frequency	50 60	Select the frequency of the electrical power system, in Hz.
Date	Date	DD-MMM-YYYY	Set the current date using the specified format.
Time	Time	hh:mm	Set the time using the 24-hour format.
Communication	Slave Address	1 - 247	Set the address for this device. The address must be unique for each device in a communications loop.
	Baud Rate	19200 38400 9600	Select the speed for data transmission. The baud rate must be the same for all devices in a communications loop.
	Parity	Even Odd None	Select None if the parity bit is not used. The parity setting must be the same for all devices in a communications loop. NOTE: Number of stop bits = 1.
Contrast	Contrast	1-9	Increase or decrease the value to increase or decrease the display contrast.
Reset Config	Reset Config	—	Settings are reset to their defaults, except for Password. Meter restarts.

Configuration menus for iEM3135 / iEM3155 / iEM3165 / iEM3175 / iEM3335 / iEM3355 / iEM3365 / iEM3375

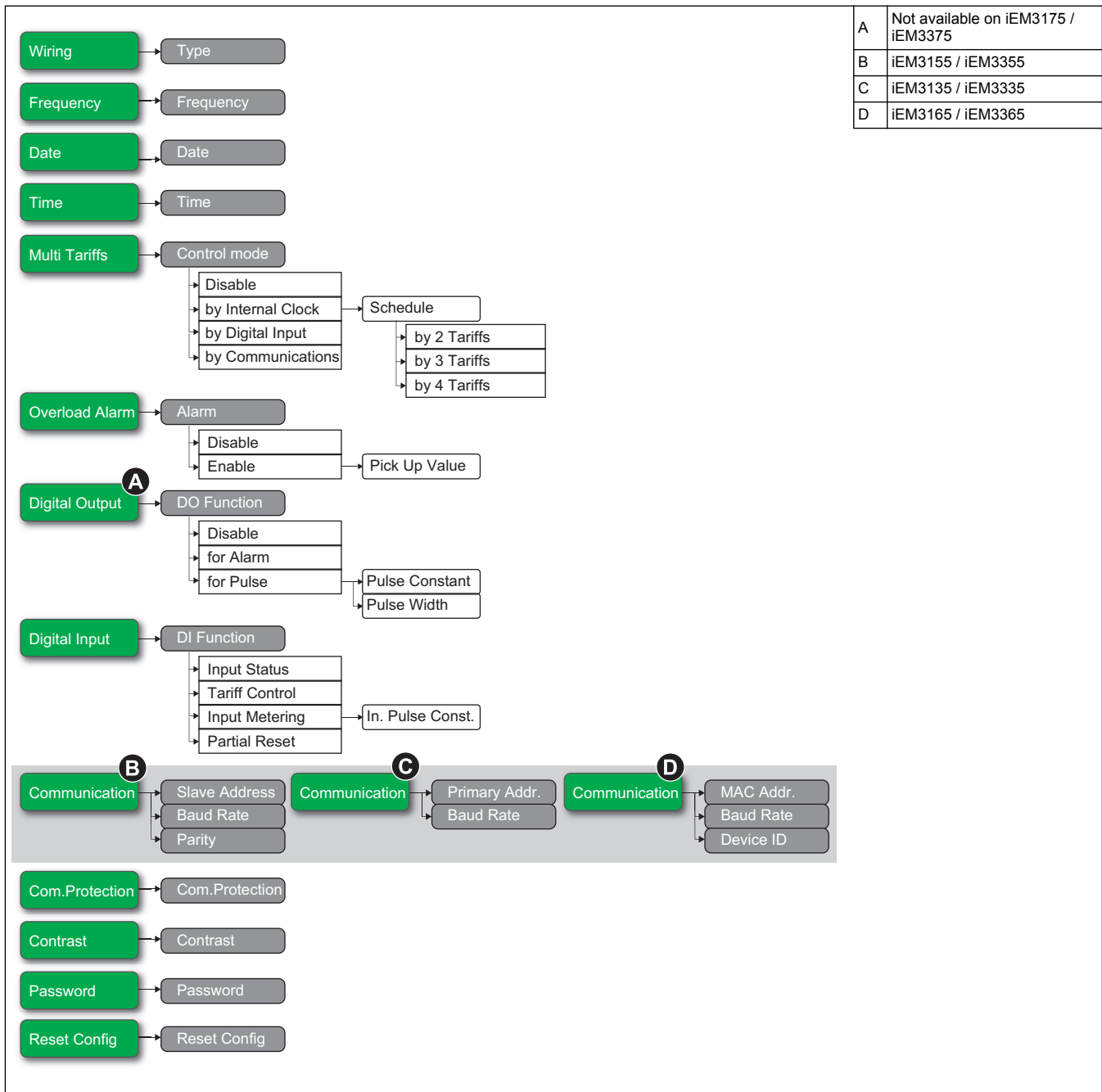

Section	Parameter	Options	Description
Wiring	Type	3PH4W 1PH2W L-N 1PH2W L-L 1PH3W L-L-N 3PH3W 1PH4W Multi L-N	Select the power system type the meter is wired to.
Frequency	Frequency	50 60	Select the frequency of the electrical power system, in Hz.
Date	Date	DD-MMM-YYYY	Set the current date using the specified format.
Time	Time	hh:mm	Set the time using the 24-hour format.

Section	Parameter	Options	Description
Multi Tariffs	Control Mode	Disable by Communication by Digital Input by Internal Clock	Select the tariff control mode: <ul style="list-style-type: none"> • Disable: the Multi Tariff function is disabled. • by Communication: the active tariff is control by communications. See the chapter for the applicable protocol for more information. • by Digital Input: the digital input is associated with the multi-tariff function. A signal to the digital input changes the active tariff. • by Internal Clock: the device clock controls the active tariff. If you set the Control Mode to by Internal Clock, you must also configure the schedule. Set the time when each tariff period starts, using the 24 hour clock format (00:00 to 23:59). The start time of the next tariff is the end time of the current tariff. For example, T2 start equals the end of T1.
Overload Alarm	Alarm	Disable Enable	Select whether or not the Overload Alarm is enabled: <ul style="list-style-type: none"> • Disable: the alarm is disabled. • Enable: the alarm is enabled. If you enabled the Overload Alarm, you must also configure the Pick Up Value in kW from 1 - 9999999.
Digital Output	DO Function	Disable for Alarm for Pulse (kWh)	Select how the digital output functions: <ul style="list-style-type: none"> • Disable: the digital output is disabled. • for Alarm: the digital output is associated with the overload alarm. The meter sends a pulse to the digital output port when the alarm is triggered. • for Pulse: The digital output is associated with energy pulsing. When this mode is selected, you must also configure the can select the energy parameter and the set the Pulse Constant (imp/kWh) and the Pulse Width (ms). <p>NOTE: the iEM3175 and iEM3375 do not have a digital output.</p>
Digital Input	DI Function	Input Status Tariff Control Input Metering Partial Reset	Select how the digital input functions: <ul style="list-style-type: none"> • Input status: the digital input records the status of the input, for example, OF, SD of a circuit breaker. • Input Metering: the digital input is associated with input metering. The meter counts and records the number of incoming pulses. If you set the DI Function to Input Metering, you must also configure In. Pulse Constant. • Tariff Control: the digital input is associated with the multi-tariff function. A signal to the digital input changes the active tariff. • Partial Reset: a signal to the digital input initiates a partial reset.
Communication (iEM3155 / iEM3355)	Slave Address	1 - 247	Set the address for this device. The address must be unique for each device in a communications loop.
	Baud Rate	19200 38400 9600	Select the speed for data transmission. The baud rate must be the same for all devices in a communications loop.
	Parity	Even Odd None	Select None if the parity bit is not used. The parity setting must be the same for all devices in a communications loop. NOTE: Number of stop bits = 1.
Communication (iEM3135 / iEM3335)	Primary Addr.	0 - 255	Set the address for this device. The address must be unique for each device in a communications loop.
	Baud Rate	2400 4800 9600 300 600 1200	Select the speed for data transmission. The baud rate must be the same for all devices in a communications loop.
Communication (iEM3165 / iEM3365)	MAC Addr.	1 - 127	Set the address for this device. The address must be unique for each device in a communications loop.
	Baud Rate	9600 19200 38400 57600 76800	Select the speed for data transmission. The baud rate must be the same for all devices in a communications loop.
	Device ID	0 - 4194303	Set the Device ID for this device. Make sure the Device ID is unique in your BACnet network.
Com.Protection	Com.Protection	Enable Disable	Protects selected settings and resets from configuration via communications.
Contrast	Contrast	1-9	Increase or decrease the value to increase or decrease the display contrast.
Password	Password	0-9999	Sets the password for accessing the meter configuration screens and resets.
Reset Config	Reset Config	—	Settings are reset to their defaults, except for Password. Meter restarts.

Configuration menus for iEM3200 / iEM3210 / iEM3215

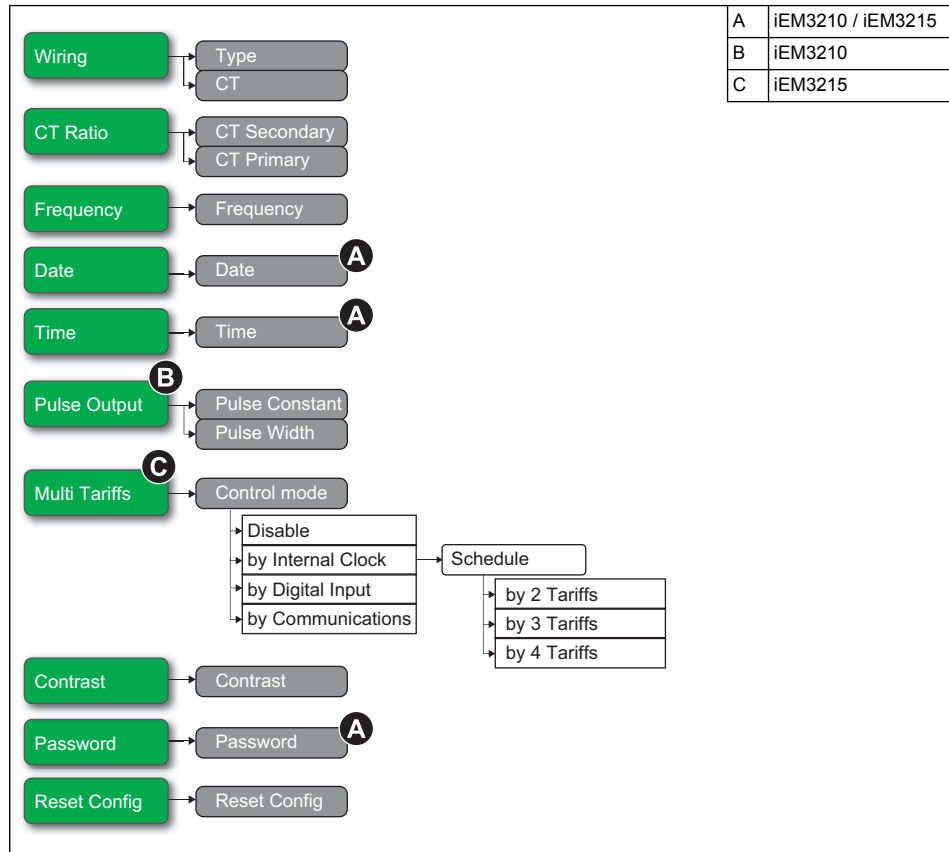

Section	Parameter	Options	Description
Wiring	Type	3PH3W 3PH4W 1PH2W L-N 1PH2W L-L 1PH3W L-L-N	Select the power system type the meter is wired to.
	CT	3CTs on I1, I2, I3 1 CT on I1 2 CTs on I1, I3	Define how many current transformers (CT) are connected to the meter and which terminals they are connected to.
CT Ratio	CT Secondary	1 5	Select the size of the CT secondary, in Amps.
	CT Primary	1 - 32767	Enter the size of the CT primary, in Amps.
Frequency	Frequency	50 60	Select the frequency of the electrical power system, in Hz.
Date (iEM3210 / iEM3215)	Date	DD-MMM-YYYY	Set the current date using the specified format.
Time (iEM3210 / iEM3215)	Time	hh:mm	Set the time using the 24-hour format.
Pulse Output (iEM3210)	Pulse Constant (imp/kWh)	0.01 0.1 1 10 100 500	Set the pulses per kWh for the pulse output.
	Pulse Width (ms)	50 100 200 300	Set the pulse width (ON time).

Section	Parameter	Options	Description
Multi Tariffs (iEM3215)	Control Mode	Disable by Internal Clock	Select the tariff control mode: <ul style="list-style-type: none"> • Disable: the Multi Tariff function is disabled. • by Digital Input: the digital input is associated with the multi-tariff function. A signal to the digital input changes the active tariff. • by Internal Clock: the device clock controls the active tariff. If you set the Control Mode to by Internal Clock, you must also configure the schedule. Set the time when each tariff period starts, using the 24 hour clock format (00:00 to 23:59). The start time of the next tariff is the end time of the current tariff. For example, T2 start equals the end of T1.
Contrast	Contrast	1-9	Increase or decrease the value to increase or decrease the display contrast.
Password (iEM3210 / iEM3215)	Password	0-9999	Sets the password for accessing the meter configuration screens and resets.
Reset Config	Reset Config	—	Settings are reset to their defaults, except for Password. Meter restarts.

Configuration menus for iEM3250

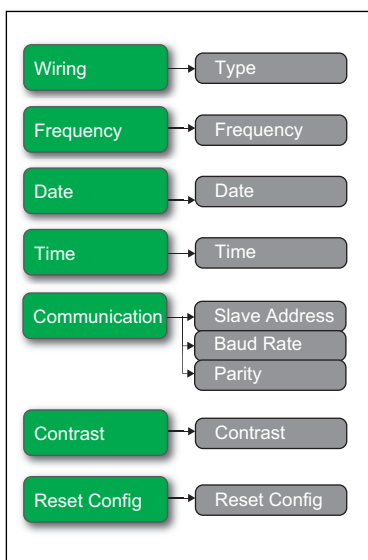

Section	Parameter	Options	Description
Wiring	Type	3PH4W 1PH2W L-N 1PH2W L-L 1PH3W L-L-N 3PH3W 1PH4W Multi L-N	Select the power system type the meter is wired to.
Frequency	Frequency	50 60	Select the frequency of the electrical power system, in Hz.
Date	Date	DD-MMM-YYYY	Set the current date using the specified format.
Time	Time	hh:mm	Set the time using the 24-hour format.
Communication	Slave Address	1 - 247	Set the address for this device. The address must be unique for each device in a communications loop.
	Baud Rate	19200 38400 9600	Select the speed for data transmission. The baud rate must be the same for all devices in a communications loop.
	Parity	Even Odd None	Select None if the parity bit is not used. The parity setting must be the same for all devices in a communications loop. NOTE: Number of stop bits = 1.
Contrast	Contrast	1-9	Increase or decrease the value to increase or decrease the display contrast.
Reset Config	Reset Config	—	Settings are reset to their defaults, except for Password. Meter restarts.

Configuration menus for iEM3235 / iEM3255 / iEM3265 / iEM3275

A	iEM3235 / iEM3255 / iEM3265
B	iEM3255
C	iEM3235
D	iEM3265

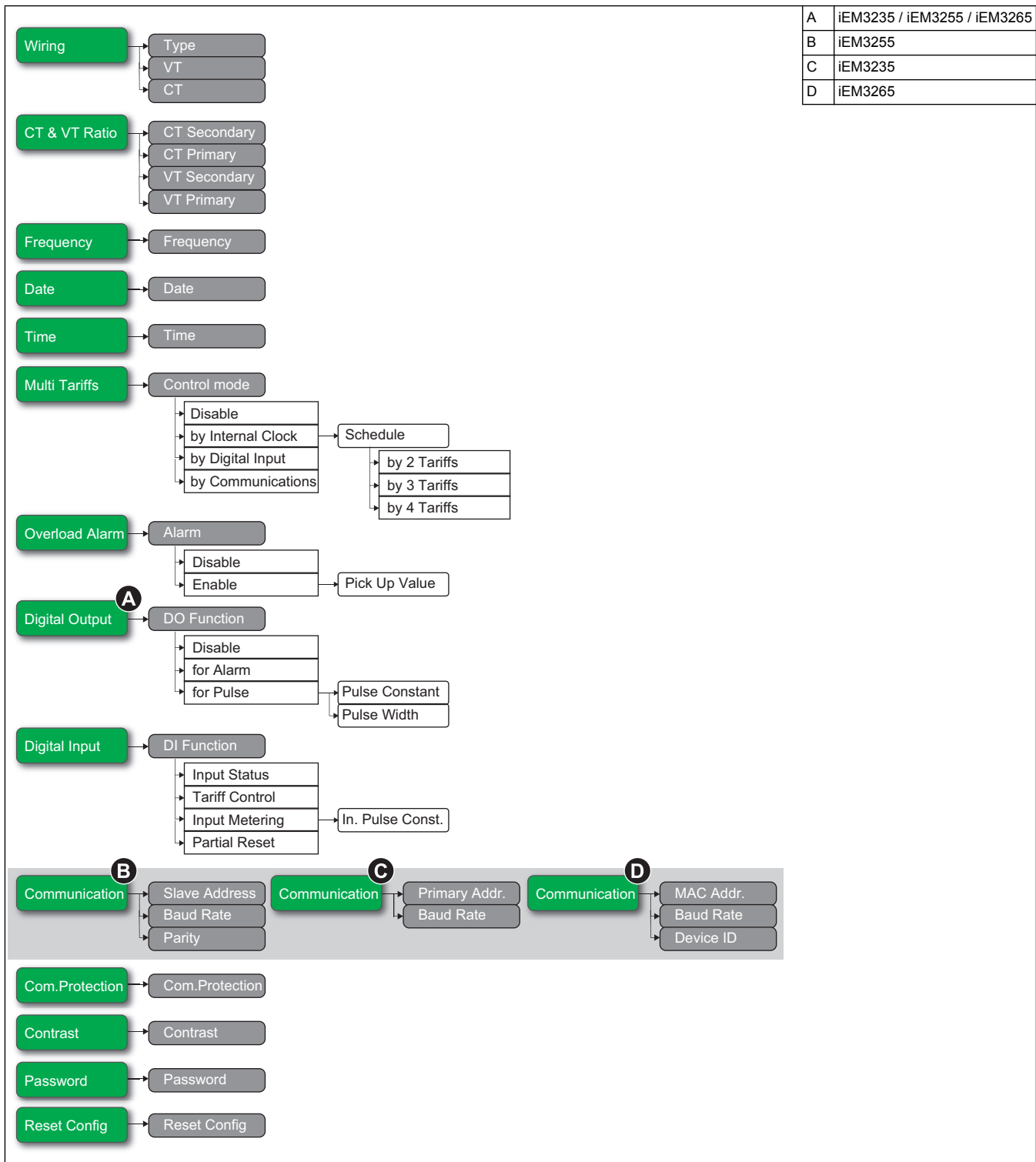

Section	Parameter	Options	Description
Wiring	Type	3PH3W 3PH4W 1PH2W L-N 1PH2W L-L 1PH3W L-L-N 1PH4W Multi L-N	Select the power system type the meter is wired to.
	VT	Direct-NoVT Wye(3VTs) Delta(2VTs)	Select how many voltage transformers (VT) are connected to the electrical power system.
	CT	3CTs on I1, I2, I3 1 CT on I1 2 CTs on I1, I3	Define how many current transformers (CT) are connected to the meter and which terminals they are connected to.
CT & VT Ratio	CT Secondary	1 5	Select the size of the CT secondary, in Amps.
	CT Primary	1 - 32767	Enter the size of the CT primary, in Amps.
	VT Secondary	100 110 115 120	Select the size of the VT secondary, in Volts.
	VT Primary	1 - 1000000	Enter the size of the VT primary, in Volts.
Frequency	Frequency	50 60	Select the frequency of the electrical power system, in Hz.
Date	Date	DD-MMM-YYYY	Set the current date using the specified format.
Time	Time	hh:mm	Set the time using the 24-hour format.
Multi Tariffs	Control Mode	Disable by Communication by Digital Input by Internal Clock	Select the tariff control mode: <ul style="list-style-type: none"> • Disable: the Multi Tariff function is disabled. • by Communication: the active tariff is control by communications. See the chapter for the applicable protocol for more information. • by Digital Input: the digital input is associated with the multi-tariff function. A signal to the digital input changes the active tariff. • by Internal Clock: the device clock controls the active tariff. If you set the Control Mode to by Internal Clock, you must also configure the schedule. Set the time when each tariff period starts, using the 24 hour clock format (00:00 to 23:59). The start time of the next tariff is the end time of the current tariff. For example, T2 start equals the end of T1.
Overload Alarm	Alarm	Disable Enable	Select whether or not the Overload Alarm is enabled: <ul style="list-style-type: none"> • Disable: the alarm is disabled. • Enable: the alarm is enabled. If you enabled the Overload Alarm, you must also configure the Pick Up Value in kW from 1 - 9999999.
Digital Output	DO Function	Disable for Alarm for Pulse (kWh)	Select how the digital output functions: <ul style="list-style-type: none"> • Disable: the digital output is disabled. • for Alarm: the digital output is associated with the overload alarm. The meter sends a pulse to the digital output port when the alarm is triggered. • for Pulse: The digital output is associated with energy pulsing. When this mode is selected, you must also configure the can select the energy parameter and the set the Pulse Constant (imp/kWh) and the Pulse Width (ms). <p>NOTE: the iEM3275 does not have a digital output.</p>
Digital Input	DI Function	Input Status Tariff Control Input Metering Partial Reset	Select how the digital input functions: <ul style="list-style-type: none"> • Input status: the digital input records the status of the input, for example, OF, SD of a circuit breaker. • Input Metering: the digital input is associated with input metering. The meter counts and records the number of incoming pulses. If you set the DI Function to Input Metering, you must also configure In. Pulse Constant. • Tariff Control: the digital input is associated with the multi-tariff function. A signal to the digital input changes the active tariff. • Partial Reset: a signal to the digital input initiates a partial reset.
Communication (iEM3255)	Slave Address	1 - 247	Set the address for this device. The address must be unique for each device in a communications loop.
	Baud Rate	19200 38400 9600	Select the speed for data transmission. The baud rate must be the same for all devices in a communications loop.
	Parity	Even Odd None	Select None if the parity bit is not used. The parity setting must be the same for all devices in a communications loop. NOTE: Number of stop bits = 1.

Section	Parameter	Options	Description
Communication (iEM3235)	Primary Addr.	0 - 255	Set the address for this device. The address must be unique for each device in a communications loop.
	Baud Rate	2400 4800 9600 300 600 1200	Select the speed for data transmission. The baud rate must be the same for all devices in a communications loop.
Communication (iEM3265)	MAC Addr.	1 - 127	Set the address for this device. The address must be unique for each device in a communications loop.
	Baud Rate	9600 19200 38400 57600 76800	Select the speed for data transmission. The baud rate must be the same for all devices in a communications loop.
	Device ID	0 - 4194303	Set the Device ID for this device. Make sure the Device ID is unique in your BACnet network.
Com.Protection	Com.Protection	Enable Disable	Protects selected settings and resets from configuration via communications.
Contrast	Contrast	1-9	Increase or decrease the value to increase or decrease the display contrast.
Password	Password	0-9999	Sets the password for accessing the meter configuration screens and resets.
Reset Config	Reset Config	—	Settings are reset to their defaults, except for Password. Meter restarts.

Chapter 5 Communications via Modbus RS-485

What is in this chapter?

This chapter contains the following sections:

Modbus communication overview	51
Modbus functions	52
Command interface	53
Modbus register list	57
Read Device Identification	61

Modbus communication overview

Modbus RTU protocol is available on the iEM3150, iEM3155, iEM3250, iEM3255, iEM3350 and iEM3355.

The information in this section assumes that you have an advanced understanding of Modbus communications, your communications network and the power system that your meter is connected to.

There are three different ways of using Modbus communication:

- by sending commands using the command interface (see “Command interface overview” on page 53)
- by reading the Modbus registers (see “Modbus register list” on page 57)
- by reading Device Identification (see “Read Device Identification” on page 61)

Modbus communications settings

Before communicating with the device using Modbus protocol, use the display to configure the following settings:

Settings	Possible values
Baud rate	9600 Baud 19 200 Baud 38 400 Baud
Parity	Odd Even None NOTE: number of stop bits = 1
Address	1–247

Communications LED indicator for Modbus devices

The yellow communications LED indicates the status of communication between the meter and the master as follows:

If...	Then...
The LED is flashing	Communication with the device has been established. NOTE: If there is an error online, the LED also flashes.
The LED is off	There is no active communication between the master and the slave

Related topics

- For more information on the Modbus protocol, see the Modbus organization website at www.modbus.org.
- See “Hardware overview” on page 16 for the location of the communications LED.

Modbus functions

Function list

The table below lists the supported Modbus functions:

Function code		Function name
Decimal	Hexadecimal	
3	0x03	Read Holding Registers
16	0x10	Write Multiple Registers
43/14	0x2B/0x0E	Read Device Identification

For example:

- To read different parameters from the meter, use function 3 (Read).
- To change the tariff, use function 16 (Write) to send a command to the meter.

Table format

Register tables have the following columns:

Register Address	Action (R/W/WC)	Size	Type	Units	Range	Description
------------------	-----------------	------	------	-------	-------	-------------

- *Register Address*: Modbus address of register encoded in the Modbus frame, in decimal (dec)
- *Action*: The read/write/write by command property of the register
- *Size*: The data size in Int16
- *Type*: The encoding data type
- *Units*: The unit of the register value
- *Range*: The permitted values for this variable, usually a subset of what the format allows
- *Description*: Provides information about the register and the values that apply

Unit table

The following data types appear in the Modbus register list:

Type	Description	Range
UInt16	16 bit unsigned integer	0 – 65535
Int16	16 bit signed integer	-32768 to +32767
UInt32	32 bit unsigned integer	0 – 4 294 967 295
Int64	64 bit unsigned integer	0 – 18 446 744 073 709 551 615
UTF8	8 bit field	multibyte character encoding for Unicode
Float32	32 bit value	Standard representation IEEE for floating number (with single precision)
Bitmap	—	—
DATETIME	See below	—

DATETIME format:

Word	Bits																
	15	14	13	12	11	10	9	8	7	6	5	4	3	2	1	0	
1	Reserved (0)								R4 (0)	Year (0 – 127)							
2	0				Month (1 – 12)				WD (0)				Day (1 – 31)				
3	SU (0)		0		Hour (0 – 23)				iV		0		Minute (0 – 59)				
4	Millisecond (0 – 59999)																
R4 :									Reserved Bit								
Year :									7 bits (year from 2000)								
Month :									4 bits								
Day :									5 bits								
Hour :									5 bits								
Minute :									6 bits								
Millisecond :									2 octets								
WD (day of the week) :									1–7: Sunday–Saturday								
SU (summer time) :									Bit to 0 if this parameter is not used.								
iV (validity of received data) :									Bit to 0 if this parameter is not valid or not used.								

Command interface

Command interface overview

The command interface allows you to configure the meter by sending specific command requests using Modbus function 16.

Command request

The following table describes a Modbus command request:

Slave Number	Function Code	Command block		CRC
		Register Address	Command Description	
1–247	16	5250 (up to 5374)	The command is made of a command number and a set of parameters. See the detailed description of each command in the command list. NOTE: All the reserved parameters can be considered as any value, e.g. 0.	Checking

The following table describes the command block:

Register Address	Content	Size (Int16)	Data (example)
5250	Command Number	1	2008 (Set Tariff)
5251	(Reserved)	1	0
5252–5374	Parameter	n	4 (Tariff=4) NOTE: Command number 2008 supports only one parameter with the size of 1.

Command result

The command result can be obtained by reading registers 5375 and 5376.

The following table describes the command result:

Register Address	Content	Size (Int16)	Data (example)
5375	Requested Command Number	1	2008 (Set Tariff)
5376	Result Command result codes: <ul style="list-style-type: none"> • 0 = Valid Operation • 3000 = Invalid Command • 3001 = Invalid Parameter • 3002 = Invalid Number of Parameters • 3007 = Operation Not Performed 	1	0 (Valid Operation)

Command list

Set Date/Time

Command Number	Action (R/W)	Size	Type	Unit	Range	Description
1003	W	1	UInt16	—	—	(Reserved)
	W	1	UInt16	—	2000–2099	Year
	W	1	UInt16	—	1–12	Month
	W	1	UInt16	—	1–31	Day
	W	1	UInt16	—	23	Hour
	W	1	UInt16	—	0–59	Minute
	W	1	UInt16	—	0–59	Second
	W	1	UInt16	—	—	(Reserved)

Set Wiring

Command Number	Action (R/W)	Size	Type	Unit	Range	Description
2000	W	1	UInt16	–	–	(Reserved)
	W	1	UInt16	–	–	(Reserved)
	W	1	UInt16	–	–	(Reserved)
	W	1	UInt16	–	0, 1, 2, 3, 11,13	Power System Configuration 0 = 1PH2W L-N 1 = 1PH2W L-L 2 = 1PH3W L-L-N 3 = 3PH3W 11 = 3PH4W 13 = 1PH4W L-N
	W	1	UInt16	Hz	50, 60	Nominal Frequency
	W	2	Float32	–	–	(Reserved)
	W	2	Float32	–	–	(Reserved)
	W	2	Float32	–	–	(Reserved)
	W	1	UInt16	–	–	(Reserved)
	W	1	UInt16	–	–	(Reserved)
	W	2	Float32	V	VT Secondary–1000000.0	VT Primary NOTE: For iEM3250 / iEM3255. Reserved by iEM3150 / iEM3155 / iEM3350 / iEM3355
	W	1	UInt16	V	100, 110, 115, 120	VT Secondary NOTE: For iEM3250 / iEM3255. Reserved by iEM3150 / iEM3155 / iEM3350 / iEM3355
	W	1	UInt16	–	1, 2, 3	Number of CTs NOTE: For iEM3250 / iEM3255. Reserved by iEM3150 / iEM3155 / iEM3350 / iEM3355
	W	1	UInt16	A	1–32767	CT Primary NOTE: For iEM3250 / iEM3255. Reserved by iEM3150 / iEM3155 / iEM3350 / iEM3355
	W	1	UInt16	A	1, 5	CT Secondary NOTE: For iEM3250 / iEM3255. Reserved by iEM3150 / iEM3155 / iEM3350 / iEM3355
	W	1	UInt16	–	–	(Reserved)
	W	1	UInt16	–	–	(Reserved)
	W	1	UInt16	–	–	(Reserved)
	W	1	UInt16	–	–	(Reserved)
W	1	UInt16	–	0, 1, 2	VT Connection type: 0 = Direct Connect 1 = 3PH3W (2 VTs) 2 = 3PH4W (3 VTs) NOTE: For iEM3250 / iEM3255. Reserved by iEM3150 / iEM3155 / iEM3350 / iEM3355	

Set Pulse Output (iEM3155 / iEM3255 / iEM3355)

Command Number	Action (R/W)	Size	Type	Unit	Range	Description
2003	W	1	UInt16	—	—	(Reserved)
	W	1	UInt16	—	—	(Reserved)
	W	1	UInt16	—	0, 1	Pulse Output enable / disable 0 = Disable 1 = Enable
	W	2	Float32	pulse/kWh	iEM3155 / iEM3355: 1, 10, 20, 100, 200, 1000 iEM3255: 0.01, 0.1, 1, 10, 100, 500	Pulse constant
	W	1	UInt16	—	—	(Reserved)
	W	1	UInt16	—	—	(Reserved)
	W	2	Float32	—	—	(Reserved)
	W	1	UInt16	—	—	(Reserved)
	W	1	UInt16	—	—	(Reserved)
	W	2	Float32	—	—	(Reserved)
2038	W	1	UInt16	—	—	(Reserved)
	W	1	UInt16	—	—	(Reserved)
	W	1	UInt16	ms	50, 100, 200, 300	Pulse width

Set Tariff (iEM3155 / iEM3255 / iEM3355)

Command Number	Action (R/W)	Size	Type	Unit	Range	Description
2060	W	1	UInt16	—	—	(Reserved)
	W	1	UInt16	—	0, 1, 2, 4	Multi Tariff Mode 0 = Disable Multi Tariff 1 = Use COM as Tariff Control (maximum 4 tariffs) 2 = Use Digital Input as Tariff Control (2 tariffs) 4 = Use Internal Clock as Tariff Control (maximum 4 tariffs)
2008	W	1	UInt16	—	—	(Reserved)
	W	1	UInt16	—	1-4	Tariff 1 = T1 2 = T2 3 = T3 4 = T4 NOTE: You can only set the tariff using this method if the Tariff Mode is set to by Communication.

Set Digital Input as Partial Energy Reset (iEM3155 / iEM3255 / iEM3355)

Command Number	Action (R/W)	Size	Type	Unit	Range	Description
6017	W	1	UInt16	—	—	(Reserved)
	W	1	UInt16	—	0, 1	Digital Input to Associate: 0 = Disable 1 = Enable

Input Metering Setup (iEM3155 / iEM3255 / iEM3355)

Command Number	Action (R/W)	Size	Type	Unit	Range	Description
6014	W	1	UInt16	-	-	(Reserved)
	W	1	UInt16	-	1	Input Metering Channel
	W	20	UTF8	-	string size <= 40	Label
	W	2	Float32	-	1-10000	Pulse Weight
	W	1	UInt16	-	-	(Reserved)
	W	1	UInt16	-	0, 1	Digital Input Association: 0 = Disable 1 = Enable

Overload Alarm Setup (iEM3155 / iEM3255 / iEM3355)

Command Number	Action (R/W)	Size	Type	Unit	Range	Description
7000	W	1	UInt16	-	-	(Reserved)
	W	1	UInt16	-	9	Alarm ID
	W	1	UInt16	-	-	(Reserved)
	W	1	UInt16	-	-	(Reserved)
	W	1	UInt16	-	-	(Reserved)
	W	1	UInt16	-	0, 1	0 = Disable 1 = Enable
	W	2	Float32	-	0.0-1e10	Pickup value
	W	2	UInt32	-	-	(Reserved)
	W	2	Float32	-	-	(Reserved)
	W	2	UInt32	-	-	(Reserved)
	W	1	UInt16	-	-	(Reserved)
	W	4	UInt16	-	-	(Reserved)
	W	1	UInt16	-	-	(Reserved)
	W	1	UInt16	-	-	(Reserved)
20000	W	1	UInt16	-	-	(Reserved)
	W	2	Float32	-	-	(Reserved)
	W	2	UInt32	-	-	(Reserved)
	W	1	Bitmap	-	0,1	Digital Output to Associate 0 = Unassociated 1 = Associated
20001	W	1	UInt16	-	-	Acknowledge the Overload Alarm

Communications Setup

Command Number	Action (R/W)	Size	Type	Unit	Range	Description
5000	W	1	UInt16	-	-	(Reserved)
	W	1	UInt16	-	-	(Reserved)
	W	1	UInt16	-	-	(Reserved)
	W	1	UInt16	-	1-247	Address
	W	1	UInt16	-	0, 1, 2	Baud Rate 0 = 9600 1 = 19200 2 = 38400
	W	1	UInt16	-	0, 1, 2	Parity 0 = Even 1 = Odd 2 = None
	W	1	UInt16	-	-	(Reserved)

Reset Partial Energy Counters

Command Number	Action (R/W)	Size	Type	Unit	Range	Description
2020	W	1	UInt16	–	–	(Reserved) iEM3150/iEM3250/iEM3350: Partial Active Energy and Phase Energy registers will be reset. iEM3155/iEM3255/iEM3355: Partial Active / Reactive Energy, Energy by tariff and Phase Energy registers will be reset.

Reset Input Metering Counter (iEM3155 / iEM3255 / iEM3355)

Command Number	Action (R/W)	Size	Type	Unit	Range	Description
2023	W	1	UInt16	–	–	(Reserved)

Modbus register list

System

Register Address	Action (R/W/WC)	Size	Type	Units	Description
30	R	20	UTF8	–	Meter Name
50	R	20	UTF8	–	Meter Model
70	R	20	UTF8	–	Manufacturer
130	R	2	UInt32	–	Serial Number
132	R	4	DATETIME	–	Date of Manufacture
136	R	5	UTF8	–	Hardware Revision
1637	R	1	UInt16	–	Present Firmware Version (DLF format): X.Y.ZTT
1845–1848	R/WC	1 X 4	UInt16	–	Date/Time Reg. 1845: Year (b6:b0) 0–99 (year from 2000 to 2099) Reg. 1846: Month (b11:b8), Weekday (b7:b5), Day (b4:b0) Reg. 1847: Hour (b12:b8), Minute (b5:b0) Reg. 1848: Millisecond

Meter Setup and Status

Register Address	Action (R/W/WC)	Size	Type	Units	Description
2004	R	2	UInt32	Second	Meter Operation Timer Not applicable for iEM3150 / iEM3250 / iEM3350
2014	R	1	UInt16	–	Number of Phases
2015	R	1	UInt16	–	Number of Wires
2016	R/WC	1	UInt16	–	Power System 0 = 1PH2W L–N 1 = 1PH2W L–L 2 = 1PH3W L–L with N 3 = 3PH3W 11 = 3PH4W 13 = 1PH4W multi L with N
2017	R/WC	1	UInt16	Hz	Nominal Frequency
2025	R	1	UInt16	–	Number VTs Not applicable for iEM3150 / iEM3155 / iEM3350 / iEM3355
2026	R/WC	2	Float32	V	VT Primary Not applicable for iEM3150 / iEM3155 / iEM3350 / iEM3355
2028	R/WC	1	UInt16	V	VT Secondary Not applicable for iEM3150 / iEM3155 / iEM3350 / iEM3355
2029	R/WC	1	UInt16	–	Number CTs Not applicable for iEM3150 / iEM3155 / iEM3350 / iEM3355
2030	R/WC	1	UInt16	A	CT Primary Not applicable for iEM3150 / iEM3155 / iEM3350 / iEM3355

Register Address	Action (R/W/WC)	Size	Type	Units	Description
2031	R/WC	1	UInt16	A	CT Secondary Not applicable for iEM3150 / iEM3155 / iEM3350 / iEM3355
2036	R/WC	1	UInt16	-	VT Connection Type 0 = Direct Connect 1 = 3PH3W (2 VTs) 2 = 3PH4W (3 VTs) Not applicable for iEM3150 / iEM3155 / iEM3350 / iEM3355

Energy Pulse Output Setup (iEM3155 / iEM3255 / iEM3355)

Register Address	Action (R/W/WC)	Size	Type	Units	Description
2129	R/WC	1	UInt16	Millisecond	Energy Pulse Duration
2131	R/WC	1	UInt16	-	Digital Output Association 0 = Disable 1 = DO1 enable for active energy pulse output
2132	R/WC	2	Float32	pulse/kWh	Pulse Weight

Command Interface

Register Address	Action (R/W/WC)	Size	Type	Units	Description
5250	R/W	1	UInt16	-	Requested Command
5252	R/W	1	UInt16	-	Command Parameter 001
5374	R/W	1	UInt16	-	Command Parameter 123
5375	R	1	UInt16	-	Command Status
5376	R	1	UInt16	-	Command Result codes: 0 = Valid Operation 3000 = Invalid Command 3001 = Invalid Parameter 3002 = Invalid Number of Parameters 3007 = Operation Not Performed
5377	R/W	1	UInt16	-	Command Data 001
5499	R	1	UInt16	-	Command Data 123

Communication

Register Address	Action (R/W/WC)	Size	Type	Units	Description
6500	R	1	UInt16	-	Protocol 0 = Modbus
6501	R/WC	1	UInt16	-	Address
6502	R/WC	1	UInt16	-	Baud Rate: 0 = 9600 1 = 19 200 2 = 38 400
6503	R/WC	1	UInt16	-	Parity: 0 = Even 1 = Odd 2 = None NOTE: number of stop bits = 1

Input Metering Setup (iEM3155 / iEM3255 / iEM3355)

Register Address	Action (R/W/WC)	Size	Type	Units	Description
7032	R/WC	20	UTF8	-	Label

Register Address	Action (R/W/WC)	Size	Type	Units	Description
7052	R/WC	2	Float32	pulse/unit	Pulse Constant
7055	R/WC	1	UInt16	–	Digital Input Association 0 = Disable for input metering 1 = Enable for input metering

Digital Input (iEM3155 / iEM3255 / iEM3355)

Register Address	Action (R/W/WC)	Size	Type	Units	Description
7274	R	1	UInt16	–	Digital Input Control Mode: 0 = Normal (Input Status) 2 = Multi Tariff Control 3 = Input Metering 5 = All Energy Reset
8905	R	2	Bitmap	–	Digital Input Status (only Bit 1 is used): Bit 1 = 0, relay open Bit 1 = 1, relay closed

Digital Output (iEM3155 / iEM3255 / iEM3355)

Register Address	Action (R/W/WC)	Size	Type	Units	Description
9673	R	1	UInt16	–	Digital Output Control Mode Status: 2 = for Alarm 3 = for Pulse (kWh) 0xFFFF = Disable

Meter Data

Current, voltage, power, power factor and frequency

Register Address	Action (R/W/WC)	Size	Type	Units	Description
Current					
3000	R	2	Float32	A	I1: phase 1 current
3002	R	2	Float32	A	I2: phase 2 current
3004	R	2	Float32	A	I3: phase 3 current
3010	R	2	Float32	A	Current Avg
Voltage					
3020	R	2	Float32	V	Voltage L1–L2
3022	R	2	Float32	V	Voltage L2–L3
3024	R	2	Float32	V	Voltage L3–L1
3026	R	2	Float32	V	Voltage L–L Avg
3028	R	2	Float32	V	Voltage L1–N
3030	R	2	Float32	V	Voltage L2–N
3032	R	2	Float32	V	Voltage L3–N
3036	R	2	Float32	V	Voltage L–N Avg
Power					
3054	R	2	Float32	kW	Active Power Phase 1
3056	R	2	Float32	kW	Active Power Phase 2
3058	R	2	Float32	kW	Active Power Phase 3
3060	R	2	Float32	kW	Total Active Power
3068	R	2	Float32	kVAR	Total Reactive Power Not applicable for iEM3150 / iEM3250 / iEM3350
3076	R	2	Float32	kVA	Total Apparent Power Not applicable for iEM3150 / iEM3250 / iEM3350

Register Address	Action (R/W/WC)	Size	Type	Units	Description
Power Factor					
3084	R	2	Float32	–	Total Power Factor: -2 < PF < -1 = Quad 2, active power negative, capacitive -1 < PF < 0 = Quad 3, active power negative, inductive 0 < PF < 1 = Quad 1, active power positive, inductive 1 < PF < 2 = Quad 4, active power positive, capacitive
Frequency					
3110	R	2	Float32	Hz	Frequency

Energy, energy by tariff and input metering

Most energy values are available in both signed 64-bit integer and 32-bit floating point format.

The energy and energy by tariff measurements listed below are preserved through power failures.

Energy reset and active tariff information					
Register Address	Action (R/W/WC)	Size	Type	Units	Description
3252	R	4	DATETIME	–	Energy Reset Date and Time
3554	R	4	DATETIME	–	Input Metering Accumulation Reset Date and Time Not applicable for iEM3150 / iEM3250 / iEM3350
4191	R/WC	1	UInt16	–	MultiTariffs Energy Active Rate 0: multi tariff disabled 1 to 4: rate A to rate D Not applicable for iEM3150 / iEM3250 / iEM3350 NOTE: You can only set the tariff using this method if the Tariff Mode is set to by Communication.

Energy values – 64-bit integer					
Register Address	Action (R/W/WC)	Size	Type	Units	Description
Total Energy (cannot be reset)					
3204	R	4	Int64	Wh	Total Active Energy Import
3208	R	4	Int64	Wh	Total Active Energy Export Not applicable for iEM3150 / iEM3250 / iEM3350
3220	R	4	Int64	VARh	Total Reactive Energy Import Not applicable for iEM3150 / iEM3250 / iEM3350
3224	R	4	Int64	VARh	Total Reactive Energy Export Not applicable for iEM3150 / iEM3250 / iEM3350
Partial Energy					
3256	R	4	Int64	Wh	Partial Active Energy Import
3272	R	4	Int64	VARh	Partial Reactive Energy Import Not applicable for iEM3150 / iEM3250 / iEM3350
Phase Energy					
3518	R	4	Int64	Wh	Active Energy Import Phase 1
3522	R	4	Int64	Wh	Active Energy Import Phase 2
3526	R	4	Int64	Wh	Active Energy Import Phase 3
Input Metering Counter					
3558	R	4	Int64	Unit	Input Metering Accumulation Not applicable for iEM3150 / iEM3250 / iEM3350
Energy by Tariff (iEM3155 / iEM3255 / iEM3355 only)					
4196	R	4	Int64	Wh	Rate A Active Energy Import
4200	R	4	Int64	Wh	Rate B Active Energy Import
4204	R	4	Int64	Wh	Rate C Active Energy Import
4208	R	4	Int64	Wh	Rate D Active Energy Import

Energy values – 32-bit floating point					
Register Address	Action (R/W/WC)	Size	Type	Units	Description
Total Energy (cannot be reset)					
45100	R	2	Float32	Wh	Total Active Energy Import
45102	R	2	Float32	Wh	Total Active Energy Export Not applicable for iEM3150 / iEM3250 / iEM3350
45104	R	2	Float32	VARh	Total Reactive Energy Import Not applicable for iEM3150 / iEM3250 / iEM3350
45106	R	2	Float32	VARh	Total Reactive Energy Export Not applicable for iEM3150 / iEM3250 / iEM3350
Partial Energy					
45108	R	2	Float32	Wh	Partial Active Energy Import
45110	R	2	Float32	VARh	Partial Reactive Energy Import Not applicable for iEM3150 / iEM3250 / iEM3350
Phase Energy					
45112	R	2	Float32	Wh	Active Energy Import Phase 1
45114	R	2	Float32	Wh	Active Energy Import Phase 2
45116	R	2	Float32	Wh	Active Energy Import Phase 3
Input Metering Counter					
45118	R	2	Float32	Unit	Input Metering Accumulation Not applicable for iEM3150 / iEM3250 / iEM3350
Energy by Tariff (iEM3155 / iEM3255 / iEM3355 only)					
45120	R	2	Float32	Wh	Rate A Active Energy Import
45122	R	2	Float32	Wh	Rate B Active Energy Import
45124	R	2	Float32	Wh	Rate C Active Energy Import
45126	R	2	Float32	Wh	Rate D Active Energy Import

Overload Alarm (iEM3155 / iEM3255 / iEM3355)

Register Address	Action (R/W/WC)	Size	Type	Units	Description
45001	R/WC	1	Bitmap	–	Overload Alarm Setup: 0x0000 = Disabled 0x0100 = Enabled
45002	R/WC	2	Float32	kW	Pickup Setpoint
45004	R/WC	1	Bitmap	–	Digital Output to Associate: 0x0000 = Digital Output unassociated to overload alarm 0x0100 = Digital Output associated to overload alarm
45005	R	1	Bitmap	–	Activated Status: 0x0000 = Alarm is inactive 0x0100 = Alarm is active
45006	R	1	Bitmap	–	Unacknowledged Status: 0x0000 = Historic alarm is acknowledged by the user 0x0100 = Historic alarm is unacknowledged by the user
45007	R	4	DATETIME	–	Last Alarm - Time Stamp
45011	R	2	Float32	kW	Last Alarm - Value

Read Device Identification

The meters supports the Read Device Identification function with the mandatory objects VendorName, ProductCode and Revision Number.

Object ID	Name/Description	Length	Value	Note
0x00	VendorName	16	SchneiderElectric	–
0x01	ProductCode	09	A9MEM3150 A9MEM3155 A9MEM3250 A9MEM3255 A9MEM3350 A9MEM3355	The ProductCode value is identical to the catalog number of each device.
0x02	MajorMinorRevision	04	V1.0	Equivalent to X.Y in register 1637

The Read Device ID codes 01 and 04 are supported:

- 01 = request to get basic device identification (stream access)
- 04 = request to get one specific identification object (individual access)

The Modbus request and response are compliant with the Modbus Application Protocol Specification.

Chapter 6 Communications via LonWorks

What is in this chapter?

This chapter contains the following sections:

- LonWorks communications overview 63**
- LonWorks communication implementation 63**
- Standard network variable types (SNVTs) and configuration properties for reading data 64**
- Meter configuration properties 68**
- Echelon LonMaker plug-in for data display and meter configuration 71**

LonWorks communications overview

LonWorks communications is available on the iEM3175, iEM3275 and iEM3375.

The information in this section assumes that you have an advanced understanding of LonWorks communications, your communications network and the power system that your device is connected to.

Related topics

- See the LonMark International website at www.lonmark.org for more information on LonTalk protocol or LonWorks communications.

LonWorks communication implementation

External interface file (XIF)

The variables and configuration properties for the meter are documented in the external interface file (XIF). The XIF file is loaded onto the meter where your LNS (LonWorks Network Services) software can download it. You can also download the XIF file from www.schneider-electric.com if you need to manually add the XIF file to your software.

The LonMaker plug-ins

The plug-ins allow you to configure the meter and view meter data in Echelon LonMaker.

LED indicators for LonWorks meters

The LonWorks meters have two LonWorks status LEDs: the red service LED and the green communications LED.

Red service LED

This LED provides the status of LonWorks operations.

LED state	Description
The LED is off	The meter is configured. It may be online or offline.
The LED is flashing	The meter is unconfigured but has an application.
The LED is on	<ul style="list-style-type: none"> • The meter is unconfigured and without an application, or • There is a defective internal memory issue.

Green communications LED

This LED provides the status of the meter’s communications with the network.

LED state	Description
The LED is off	Communication is not active.
The LED is flashing	Communication is active.

Location of the service pin and Neuron ID

The service pin is located on the front panel. Press this when requested by your LNS software in order to identify the meter to your LonWorks network.

You can also find the Neuron ID on the meter label if you need to manually enter it into your LNS software.

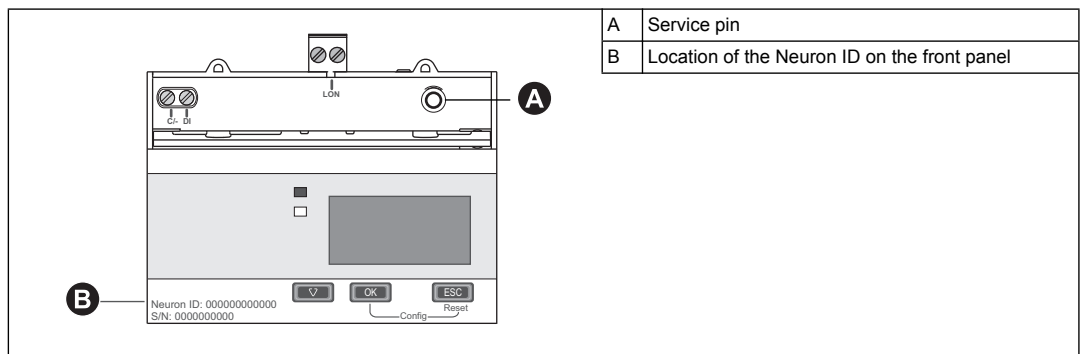

Related topics

- See “Hardware overview” on page 16 for the location of the communications LED.
- See “Input, output and communications wiring” on page 24 for information on wiring the device communications.
- See “Echelon LonMaker plug-in for data display and meter configuration” on page 71 for instructions on installing and using the LonMaker plug-in.

Standard network variable types (SNVTs) and configuration properties for reading data

The following sections outline the standard network variable types (SNVTs), the standard configuration property types (SCPTs), and user configuration property types (UCPTs) that you can access to read data from the meter.

Related topics

- See “Meter configuration properties” on page 68 for more information on configuring settings using LonWorks.

General variables

Network variable label	Type	Description
nviRequest	SCPTpartNumber	For LonWorks internal communication.
nvoStatus	SCPToemType	For LonWorks internal communication.

System variables

Network variable label	Type	Description
nvoFileDirectory	SNVT_address	Configuration parameter file directory address (LonMark)
nvoResponse	SNVT_count	Command result (LonMark)

Network variable label	Type	Description
nvoErrors	SNVT_state	Device error status Error bitmap: each bit of the bitmap provides error information about the device. If value of the bit = 1, that error is active. Bit0 = Code 101: EEPROM error Bit1 = Code 102: No calibration table Bit2 = Code 201: mismatch between frequency settings and frequency measurements Bit3 = Code 202: mismatch between wiring settings and wiring inputs Bit4 = Code 203: phase sequence reversed Bit5 = Not used Bit6 = Code 205: Date and time have been reset due to a power failure Bit7 = Not used Bit8 = Code 207: Abnormal internal clock function Bit9 = Internal data bus communications error Bit10 - 15: Not used
nciMeterModel	SNVT_str_asc (SCPTpartNumber)	Device model, stored as an ASCII string (for example, iEM3275)
nciMeterManf	SNVT_str_asc (SCPToemType)	Manufacturer name (Schneider Electric)
nciSerialNumber	SNVT_str_asc (SCPTserialNumber)	Device serial number
nciManfDateTime	SNVT_time_stamp (SCPTmanfDate)	Date of manufacture
nciDevMajVer	SCPTdevMajVer	LonWorks firmware major version (for example, 2.xx) This variable functions with nciDevMinVer to provide the device's LonWorks firmware version
nciDevMinVer	SCPTdevMinVer	LonWorks firmware minor version (for example, x.34) This variable functions with nciDevMajVer to provide the device's LonWorks firmware version
nciMeterVersion	SNVT_str_asc (UCPTMeterVersion)	Device firmware version, stored as an ASCII text string

Related topics

- See “Troubleshooting” on page 103 for more information on the error codes.
- See “Network propagation rate setup” on page 70 for information on variables that control the network update rate.

Energy and energy by tariff measurements

Most energy values are available in both signed 32-bit integer and floating point format. The SNVT is appended with *_l* for 32-bit integer values and *_f* for floating point values.

For example, the SNVTs for total active energy import are as follows:

- 32-bit integer: SNVT_elec_kwh_l
- Floating point: SNVT_elec_whr_f

The energy and energy by tariff measurements listed below are preserved through power failures.

Network variable label	Type	Description
nvoTotkWhImp	SNVT_elec_kwh_l	Total active energy import
nvoTotkWhExp	SNVT_elec_kwh_l	Total active energy export
nvoTotkVARhImp	SNVT_elec_kwh_l	Total reactive energy import
nvoTotkVARhExp	SNVT_elec_kwh_l	Total reactive energy export
nvoTotWhImp	SNVT_elec_whr_f	Total active energy import
nvoTotWhExp	SNVT_elec_whr_f	Total active energy export
nvoTotVARhImp	SNVT_elec_whr_f	Total reactive energy import
nvoTotVARhExp	SNVT_elec_whr_f	Total reactive energy export
nvoPartialkWh	SNVT_elec_kwh_l	Partial active energy import
nvoPartialkVARh	SNVT_elec_kwh_l	Partial reactive energy import
nvoPartialWh	SNVT_elec_whr_f	Partial active energy import
nvoPartialVARh	SNVT_elec_whr_f	Partial reactive energy import

Network variable label	Type	Description
nvoPh1kWh	SNVT_elec_kwh_l	Active energy import phase 1
nvoPh2kWh	SNVT_elec_kwh_l	Active energy import phase 2
nvoPh3kWh	SNVT_elec_kwh_l	Active energy import phase 3
nvoPh1Wh	SNVT_elec_whr_f	Active energy import phase 1
nvoPh2Wh	SNVT_elec_whr_f	Active energy import phase 2
nvoPh3Wh	SNVT_elec_whr_f	Active energy import phase 3
nvoTariffActRate	SNVT_count	Active tariff 0 = Multi Tariff feature is disabled 1 = rate A (tariff 1) active 2 = rate B (tariff 2) active 3 = rate C (tariff 3) active 4 = rate D (tariff 4) active
nvoTariffAkWh	SNVT_elec_kwh_l	Rate A (tariff 1) active energy import
nvoTariffBkWh	SNVT_elec_kwh_l	Rate B (tariff 2) active energy import
nvoTariffCkWh	SNVT_elec_kwh_l	Rate C (tariff 3) active energy import
nvoTariffDkWh	SNVT_elec_kwh_l	Rate D (tariff 4) active energy import
nvoTariffAWh	SNVT_elec_whr_f	Rate A (tariff 1) active energy import
nvoTariffBWh	SNVT_elec_whr_f	Rate B (tariff 2) active energy import
nvoTariffCWh	SNVT_elec_whr_f	Rate C (tariff 3) active energy import
nvoTariffDWh	SNVT_elec_whr_f	Rate D (tariff 4) active energy import
nvoInMeterAcc	SNVT_count_f	Input metering accumulation
nvoRstEnergyDT	SNVT_time_stamp	Date and time of last energy reset

Related topics

- See “Resets” on page 68 for information on resetting values.
- See “Network propagation rate setup” on page 70 for information on variables that control the network update rate.

Instantaneous (RMS) measurements

Network variable label	Type	Description
nvoActPowerPh1	SNVT_power_f	Active power Phase 1
nvoActPowerPh2	SNVT_power_f	Active power Phase 2
nvoActPowerPh3	SNVT_power_f	Active power Phase 3
nvoActPowerSum	SNVT_power_f	Total active power
nvoRctPowerSum	SNVT_power_f	Total reactive power
nvoAppPowerSum	SNVT_power_f	Total apparent power
nvoVoltsL1N	SNVT_volt_f	Voltage L1-N
nvoVoltsL2N	SNVT_volt_f	Voltage L2-N
nvoVoltsL3N	SNVT_volt_f	Voltage L3-N
nvoVoltsLNAvg	SNVT_volt_f	Average voltage line-to-neutral
nvoVoltsL1L2	SNVT_volt_f	Voltage L1-L2
nvoVoltsL2L3	SNVT_volt_f	Voltage L2-L3
nvoVoltsL3L1	SNVT_volt_f	Voltage L3-L1
nvoVoltsLLAvg	SNVT_volt_f	Average voltage line-to-line
nvoCurrentPh1	SNVT_amp_f	Phase 1 current
nvoCurrentPh2	SNVT_amp_f	Phase 2 current
nvoCurrentPh3	SNVT_amp_f	Phase 3 current
nvoCurrentAvg	SNVT_amp_f	Average current
nvoAvgPwrFactor	SNVT_count_inc_f	Total power factor
nvoFrequency	SNVT_freq_f	Frequency

Related topics

- See “Network propagation rate setup” on page 70 for information on variables that control the network update rate.

Meter status information

You can read the following network variables to obtain configuration and status information about the meter. For information on configuring the meter, see the sections on meter configuration properties and the LonWorks plug-in.

Network variable label	SNVT / UCPT type	Description
Basic information and meter configuration		
nvoDateTime	SNVT_time_stamp	Meter date and time (DD/MM/YYYY hh:mm:ss)
nvoOpTimer	SNVT_count_32	Meter operation timer: the time in seconds since the meter was last powered up
System configuration information		
nciSystemType	SNVT_count	Power system configuration: 0 = 1PH2W L-N 1 = 1PH2W L-L 2 = 1PH3W L-L with N 3 = 3PH3W 11 = 3PH4W 13 = 1PH4 wire multi L-N
nciWireNum	SNVT_count	Number of wires 2, 3, 4
nciPhaseNum	SNVT_count	Number of phases 1, 3
nciCtNum	SNVT_count	Number of CTs 1, 2, 3 NOTE: only applies to the iEM3275
nciVtNum	SNVT_count	Number of VTs 0-10 NOTE: only applies to the iEM3275
nciVtPrimary	SNVT_count_32	VT Primary NOTE: only applies to the iEM3275
nciVTSecondary	SNVT_count	VT Secondary NOTE: only applies to the iEM3275
nciCtPrimary	SNVT_count	CT Primary NOTE: only applies to the iEM3275
nciCtSecondary	SNVT_count	CT Secondary NOTE: only applies to the iEM3275
nciVtConnType	SNVT_count	VT connection type 0 = Direct connection, no VTs 1 = 3PH3W (2VTs) 2 = 3PH4W (3VTs)
nciNominalFreq	SNVT_freq_hz	System frequency 50, 60
Digital input configuration and status information		
nciDICtrMode	SNVT_count	Digital input control mode 0 = Normal (input status) 2 = Multi Tariff control 3 = Input metering 5 = All partial energy reset (configure to reset all partial energy logs)
nciDIPulseConst	SNVT_count_32	Pulse constant (pulses/unit)
nvoDIStatus	SNVT_count	Digital input status (only Bit 1 is used) 0 = relay open 1 = relay closed NOTE: The information provided by this variable only applies if the digital input control mode is set to Input Status.
Alarm status		
nvoAlmStatus	SNVT_count	Alarm status (only Bit 1 is used) 0 = Alarm is inactive 1 = Alarm is active

Network variable label	SNVT / UCPT type	Description
nvoAlmUnAckState	SNVT_count	Acknowledgement status (only Bit 1 is used): 0 = historic alarm is acknowledged by the user 1 = historic alarm is unacknowledged by the user
nvoAlmLastTime	SNVT_time_stamp	Timestamp of last alarm (DD/MM/YYYY hh:mm:ss)
nvoAlmLastValue	SNVT_power_f	Value at last alarm
nciAlmEnable	SNVT_count	Overload alarm configuration: 0 = disabled 1 = enabled
nciAlmPkUpSetPt	SNVT_power_f	Active power alarm pickup setpoint in kW

Related topics

- See “Meter configuration properties” on page 68 for information on SCPTs and UCPTs that you can use to configure the meter.
- See “Echelon LonMaker plug-in for data display and meter configuration” on page 71 for instructions on using the LNS plug-in to configure the meter.

Resets

Network variable label	Type	Description	Action
nciRstPartEnergy	SNVT_switch	Resets all partial energy accumulators to 0: <ul style="list-style-type: none"> • Partial active energy import (nvoPartialkWh, nvoPartialWh) • Partial reactive energy import (nvoPartialkVARh, nvoPartialVARh) • Rate A active energy import (nvoTariffAkWh, nvoTariffAWh) • Rate B active energy import (nvoTariffBkWh, nvoTariffBWh) • Rate C active energy import (nvoTariffCkWh, nvoTariffCWh) • Rate D active energy import (nvoTariffDkWh, nvoTariffDWh) • Active energy import phase 1 (nvoPh1kWh, nvoPh1Wh) • Active energy import phase 2 (nvoPh2kWh, nvoPh2Wh) • Active energy import phase 3 (nvoPh3kWh, nvoPh3Wh) 	To reset, set the state field to 1.
nciRstInMeterAcc	SNVT_switich	Resets input metering accumulation (nvoInMeterAcc) to 0	To reset, set the state field to 1.

Meter configuration properties

You can configure the meter using the configuration properties listed in this section. However, it is recommended that you use the Echelon LonMaker plug-in if you are configuring the meter using LonWorks communications.

NOTE: If Com. Protection is enabled, you may receive an error response when you try to configure the meter over communications.

Related topics

- See “Com. Protection setting” on page 39 for more information on the Com. Protection feature.
- See “Echelon LonMaker plug-in for data display and meter configuration” on page 71 for instructions on using the LNS plug-in to configure the device.

Date/time setup

Function profile	UCPT	Struct Members	Range / options
nciCfgDateTime	UCPTDateTime	year	2000 - 2099
		month	1 - 12
		day	1 - 31
		hour	0 - 23
		minute	0 - 59
		second	0 - 59

Basic setup

Function profile	UCPT	Struct Members	Range / options	Description
nciCfgWiring	UCPTWiring	SystemType	0, 1, 2, 3, 11, 13	0 = 1PH2W L-N 1 = 1PH2W L-L 2 = 1PH3W L-L with N 3 = 3PH3W 11 = 3PH4W 13 = 1PH4 wire multi L with N
		NominFreq	50, 60	Nominal frequency in Hz
		VtPrimary	0 - 1000000.0	The minimum value for VtPrimary must be equal to or greater than the value set for VtSecondary.
		VtSecondary	100, 110, 115, 120	—
		CtNum	1, 2, 3	—
		CtPrimary	1 - 32767	—
		CtSecondary	1, 5	—
		VtConnType	0, 1, 2	VT connection type 0 = Direct connection 1 = 3PH3W (2VTs) 2 = 3PH4W (3VTs)

Digital input setup

Function profile	UCPT	Struct Members	Range / options	Description
nciCfgDigitInpt	UCPTDigitalInput	—	0, 1	Associates the digital input to reset partial energy data: 0 = Digital input is not associated with the partial energy reset. 1 = Digital input is associated with the partial energy reset. Setting this property to 1 also updates nciDICtrlMode (UCPTDiCtrlMode) to All Energy Reset.

Input metering setup

Function profile	UCPT	Struct Members	Range / options	Description
nciCfgInptMetAcc	UCPTInputMetering	PulseWeight	1 - 10000	Sets the pulse weight (1 - 10000 ms) Setting this property also sets nciDIPulseConst (UCPTDiPulseConst) to the same value.
		DigitalAssociation	0, 1	Associates the digital input with input metering: 0 = Digital input is not associated with input metering. 1 = The digital input is associated with input metering. Setting this property to 1 also updates nciDICtrlMode (UCPTDiCtrlMode) to Input Metering.

Overload alarm setup

Function profile	UCPT	Struct Members	Range / options	Description
nciCfgOvLoadAlm	UCPTOverLoadAlarm	AlmEnable	0, 1	Enable or disable the overload alarm: 0 = Disabled 1 = Enabled
		PkUpSetpoint	1 - 9999999	The pickup value for the overload alarm
nciCfgOvLoadAck	UCPTOverLoadAlmAck	—	0, 1	Acknowledgement status (only Bit 1 is used): 0 = historic alarm is acknowledged by the user 1 = historic alarm is unacknowledged by the user

Multi Tariff setup

Function profile	UCPT	Struct Members	Range / options	Description
nciCfgCommTariff	UCPTTariffMode	—	0, 1	Set Multi Tariff control mode to Disabled or by Communication 0 = Disabled 1 = by Communication NOTE: To configure the Multi Tariff feature to be controlled by the digital input or device clock, use the HMI.
nciCfgTariffSel	UCPTTariffSelect	—	1, 2, 3, 4	Set the active tariff 1 = Rate A (tariff 1) 2 = Rate B (tariff 2) 3 = Rate C (tariff 3) 4 = Rate D (tariff 4) NOTE: You can only set the tariff using this method if the Tariff Mode is set to by Communication.

Network propagation rate setup

The following configuration properties help control network traffic by controlling the rate at which variable values are sent to your LNS.

nci variable	UCPTs/SCPTs	Applies to...	Description
nciMaxNvSntPerSec	UCPTNVUptdLimit	<ul style="list-style-type: none"> nciErrors nciAllEnergy nciAllPower nciAllVoltage nciAllCurrent nciAllPowerFactor nciFrequency. 	Limits the total number of updates sent per second for listed nci variables. If more than the specified number of updates are queued to be sent out in any 1 second period, the excess updates are delayed until the next second to reduce network traffic. The number of updates sent per second varies depending on the connection type updates from network variables that are not controlled by this configuration property.
nciErrors	SCPTmaxSendTime	<ul style="list-style-type: none"> nvoErrors 	Maximum interval, in seconds, between transmissions of error values to the network. The value of the applicable variable is sent after the interval has elapsed, regardless of whether or not the value of the variable has changed. The counter is reset to 0.

nci variable	UCPTs/SCPTs	Applies to...	Description
nciAllEnergy	SCPTminSendTime	Floating-point energy values: <ul style="list-style-type: none"> nvoTotWhImp nvoTotWhExp nvoTotVARhImp nvoTotVARhExp nvoPartialWh nvoPartialVARh nvoPh1Wh nvoPh2Wh nvoPh3Wh nvoTariffAWh nvoTariffBWh nvoTariffCWh nvoTariffDWh 	The minimum interval, in seconds, between consecutive transmissions of the listed variable values to the network. No updates to the value of the applicable variables are sent over the network until the minimum interval has elapsed, regardless of whether or not the value of the variable has changed. After an update is sent, the counter is reset to 0.
nciAllPower	SCPTminSendTime	<ul style="list-style-type: none"> nvoActPowerPh1 nvoActPowerPh2 nvoActPowerPh3 nvoActPowerSum nvoRctPowerSum nvoAppPowerSum 	
nciAllVoltage	SCPTminSendTime	<ul style="list-style-type: none"> nvoVoltsL1N nvoVoltsL2N nvoVoltsL3N nvoVoltsLNAvg nvoVoltsL1L2 nvoVoltsL2L3 nvoVoltsL3L1 nvoVoltsLLAvg 	
nciAllCurrent	SCPTminSendTime	<ul style="list-style-type: none"> nvoCurrentPh1 nvoCurrentPh2 nvoCurrentPh3 nvoCurrentAvg 	
nciAllPowerFactor	SCPTminSendTime	<ul style="list-style-type: none"> nvoAvgPwrFactor 	
nciFrequency	SCPTminSendTime	<ul style="list-style-type: none"> nvoFrequency 	

Echelon LonMaker plug-in for data display and meter configuration

The information in this section assumes that you have an advanced understanding of system administration using Echelon LonMaker.

The LonMaker plug-in provides a graphical user interface where you can view meter values and configure meter settings. Once you install and register the plug-in with LonMaker, it opens instead of the default LonMaker browser when you browse the meter in LonMaker.

To add devices to LonMaker, you need access to the device service pin when commissioning the device or your need the device Neuron ID recorded in an accessible location.

Related topics

- Refer to <http://www.echelon.com/products/tools/integration/lonmaker/> and the LonMaker documentation for more information on using LonMaker.
- See “Location of the service pin and Neuron ID” on page 64 for the location of the service pin and Neuron ID.

Installing and registering the LonMaker plug-in

Before you install the plug-in:

- Download the plug-in and XIF file for your device from www.schneider-electric.com or contact your sales representative to obtain these files.
- Make sure Echelon LonMaker is closed.

- Navigate to the location where you saved the plug-in. Extract the files if they are in a .zip file.
- Double-click setup.exe. A welcome screen appears. Click **Next**.
- Select the installation folder where you want to install the plug-in. Click **Browse** if you want to select a different location. Click **Next**. A confirmation screen appears.
- Click **Next** to begin the installation.

NOTE: If LonMaker is open, a message appears instructing you to close LonMaker and restart the plug-in installation.

A screen appears when the installation is complete. Click **Close**.

5. Navigate to **Start > Programs > Schneider Electric** and select the registration entry for the plug-in you installed (for example, **Schneider Electric iEM3275 Plugin Registration**). The **LNS Plugin Registration** dialog box appears, indicating that registration is complete.

Make sure that the plug-in appears in the list of registered plug-ins in LonMaker before you try to connect to a meter using the plug-in. If it does not appear, you may need to re-register the plug-in.

Once the plug-in is installed and registered, add the meter to LonMaker. You can either read the template (.XIF) from the device during commissioning or select the EnergyMeter5A or EnergyMeter63A template when you add the device to LonMaker.

Related topics

- Refer to the Echelon LonMaker documentation for information on registering the plug-in.

Browsing the meter using the LonMaker plug-in

In order to use the plug-in to view data and configure the meter:

- The plug-in must be installed and registered.
- The meter must be added to LonMaker and commissioned.

1. Open LonMaker.
2. Right-click the meter icon and select **Browse**. The meter plug-in appears.

NOTE: If the meter-specific plug-in does not open, the plug-in may not be correctly registered or the meter may not be properly commissioned in LonMaker. Double-check the registration and meter commissioning. Refer to the Echelon LonMaker documentation for more information.

LonMaker plug-in interface

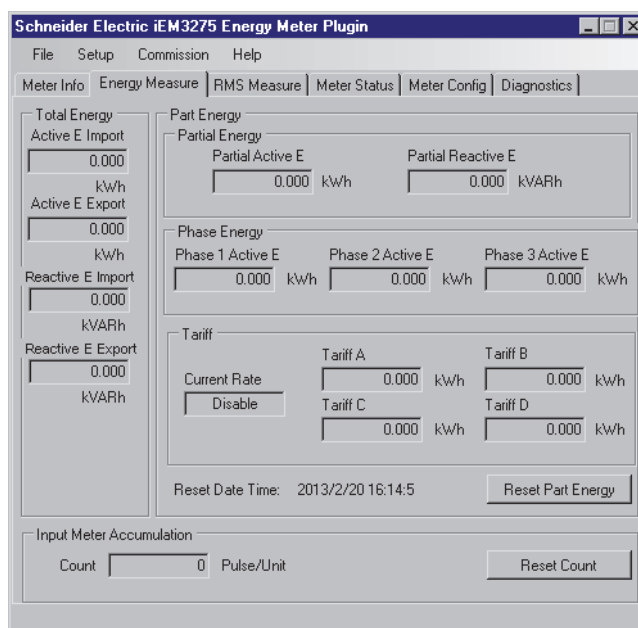

The plug-in has the following tabs:

Tab name	Description
Meter Info	This tab provides basic information about the meter (for example, model and serial number) and any active error codes.
Energy Measure	This tab provides total and partial energy values as well as energy per phase and energy by tariff information. You can also reset energy and input metering accumulations on this tab.
RMS Measure	This tab provides power, current, and voltage values as well as frequency and power factor information.

Tab name	Description
Meter Status	This tab provides information on the settings and status of the digital input and alarms as well as existing power system settings.
Meter Config	This tab provides access to the meter configuration properties, allowing you to configure power system, digital input, alarm, Multi Tariff and time settings. NOTE: If you see a message that the configuration was unsuccessful, make sure: 1) the meter is properly commissioned in LonMaker and the plug-in is communicating with the meter, and 2) that Com. Protection is disabled on the meter.
Diagnostics	This tab provides LonMaker diagnostics information related to the meter.

Chapter 7 Communications via M-Bus

What is in this chapter?

This chapter contains the following sections:

- M-Bus communications overview** 75
- M-Bus protocol support** 76
- M-Bus protocol implementation** 76
- Variable data structure telegram information** 77
- Telegram information for data records** 79
- Telegram information for meter configuration** 82
- M-Bus tool for data display and meter configuration** 85

M-Bus communications overview

M-Bus is a master / slave communications protocol where the master initiates transactions and the slave(s) respond with the requested information or action. Data is transferred using hexadecimal telegrams.

Communications via M-Bus protocol is available on the iEM3135, iEM3235 and iEM3335.

The information in this section is intended for users with an advanced understanding of M-Bus protocol, their communications network and their power system.

Configuring basic communications settings

Before communicating with the meter via M-Bus protocol, use the HMI to configure the following settings:

Setting	Possible values
Baud rate	300
	600
	1200
	2400
	4800
	9600
Primary address	1–250

Key terms

Term	Definition
C-Field	The control or function field of the telegram. It provides information about the telegram, such as the direction of data flow (master to slave or slave to master), the status of the data flow and the function of the message.
CI-Field	The control information field of the telegram. It defines the type and sequence of data to be transmitted.
Fixed data header	Contains device and manufacturer identification information.
DIF	Data information field. The DIF contains information about the function of the data (for example, instantaneous versus maximum) and the data format (for example, 16-bit integer).
DIFE	Data information field extension. A DIFE contain additional information about the data, such as tariff and subunit.
Master	A device that issues commands and receives responses from slave devices. There can be only one master per serial network.
Slave	A device that provides information or performs actions in response to requests from the master.
VIF / VIFE	Value information field and value information field extension. The VIF and VIFE contain information about the value (for example, whether it is an energy or power value). The meter uses both primary VIFE (as detailed in the M-Bus protocol documentation) and manufacturer-specific VIFE.

Related topics

- See the M-Bus organization website at www.m-bus.com for more information on the M-bus protocol.
- See “Hardware overview” on page 16 for the location of the communications LED.
- See “Communications setup” on page 84 for information on setting the baud rate using a telegram.

M-Bus protocol support

The meter supports the M-Bus protocol as follows:

- Mode 1 communications (least significant bit first).
- Telegram formats:
 - Single character
 - Short frame
 - Long frame
- Function codes (C-field bits 3-0):
 - SND_NKE: Initiates of communications between the master and slave.
 - SND_UD: The master sends user data to the slave.
 - REQ_UD2: The master requests Class 2 user data from the slave.
 - RSP_UD: The slave sends requested data to the master.
- Secondary addressing in accordance with the M-Bus standard.
- Broadcast telegrams.

Related topics

- See the M-Bus organization website at www.m-bus.com for more information on the M-Bus protocol, including secondary addressing procedures.
- See “Fixed data header” on page 77 for the meter-specific information required for secondary addressing (for example, identification number, manufacturer and medium).

M-Bus protocol implementation

M-Bus tool for viewing data and configuring the meter

The M-Bus tool provides a graphical user interface where you can view meter data and configure meter settings. To obtain the tool, go to www.schneider-electric.com and search for your meter model then select Downloads or contact your local Schneider Electric representative.

Communications LED indicator for M-Bus meters

The communications LED indicates the status of the communications between the meter and the network as follows:

LED state	Description
The LED is flashing	Communication with the meter has been established. NOTE: The LED flashes even if there is a communications error.
The LED is off	There is no active communication.

Related topics

- See “Hardware overview” on page 16 for the location of the communications LED.
- See “M-Bus tool for data display and meter configuration” on page 85 for information on obtaining and using the M-Bus tool.

Variable data structure telegram information

Fixed data header

Byte 1-4 Identification No.	Byte 5-6 Manufacturer	Byte 7 Version	Byte 8 Medium	Byte 9 Access No.	Byte 10 Status	Byte 11-12 Signature
Serial number of the meter in an 8-digit, BCD coded format The serial number can also be found on the meter front panel.	4CA3 hex = Schneider Electric	Firmware version of the communications board 10 = version 1.0	02 hex (electricity)	Counter of successful access attempts	Indicates M-Bus application errors	Not used

Data record header information

Data formats used by the meter (DIF bits 3-0)

NOTE: x in the hex value is determined by bits 7-4 of the DIF.

Format	bin	hex
No data	0000	x0
8-bit integer	0001	x1
16-bit integer	0010	x2
24-bit integer	0011	x3
32-bit integer	0100	x4
32-bit real	0101	x5
48-bit integer	0110	x6
64-bit integer	0111	x7
Variable length	1101	xD

Data function types used by the meter (DIF bits 5-4)

Function type	bin
Instantaneous	00
Maximum	01

Primary VIF used by the meter

NOTE: E denotes the extension bit; x in the hex value is determined by bits 7-4 of the VIF.

Primary VIF	bin	hex	Description
Energy	E000 0011	x3	Wh with a resolution of 10^0
Power	E000 1110	xE	kW with a resolution of 10^3
Time point	E110 1101	xD	Date and time in data type F, as detailed in the M-Bus protocol documentation
Bus address	E111 1010	xA	Data type C (unsigned integer), as detailed in the M-Bus protocol documentation
Primary VIFE	1111 1101	FD	Indicates that the first VIFE is a primary VIF extension
Manufacturer-specific VIFE	1111 1111	FF	Indicates that the next VIFE is manufacturer specific

Primary VIFE codes used by the meter

The primary VIFE codes in the table below are used by the meter when the VIF equals FD hex (1111 1101 bin).

NOTE: E denotes the extension bit; x in the hex value is determined by bits 7-4 of the VIFE.

Primary VIFE codes	bin	hex	Additional information
Manufacturer	E000 1010	xA	—
Model	E000 1100	xC	—
Voltage	E100 1001	x9	Volts with a resolution of 10^0
Current	E101 1100	xC	Amps with a resolution of 10^0
Digital output	E001 1010	xA	—
Digital input	E001 1011	xB	—

Primary VIFE codes	bin	hex	Additional information
Cumulation counter	E110 0001	x1	Input metering accumulation
Error flag	E001 0111	x7	—

Manufacturer-specific VIFE codes

The manufacturer-specific VIFE codes in the table below are used by the meter when the VIF equals FF hex (1111 1111 bin).

NOTE: E denotes the extension bit; the hex value assumes E = 0.

Description	bin	hex
L1 value	E000 0001	01
L2 value	E000 0010	02
L3 value	E000 0011	03
Export energy value	E000 1001	09
Partial energy value	E000 1101	0D
Average current	E000 0000	00
L-N Avg	E000 0100	04
L1-L2	E000 0101	05
L2-L3	E000 0110	06
L3-L1	E000 0111	07
L-L Avg	E000 1000	08
Power Factor	E000 1010	0A
Frequency	E000 1011	0B
Energy reset date and time	E000 1100	0C
Input metering reset date and time	E000 1110	0E
Input metering accumulation	E000 1111	0F
Active tariff (Energy active rate)	E001 0000	10
Tariff control mode	E001 0001	11
Meter operation timer	E010 0000	20
Number of phases	E010 0001	21
Number of wires	E010 0010	22
Power system configuration	E010 0011	23
Nominal frequency	E010 0100	24
Number of VTs	E010 0101	25
VT primary	E010 0110	26
VT secondary	E010 0111	27
Number of CTs	E010 1000	28
CT Primary	E010 1001	29
CT Secondary	E010 1010	2A
VT connection type	E010 1011	2B
Energy pulse duration	E010 1100	2C
Digital output association with active energy pulsing	E010 1101	2D
Pulse weight	E010 1110	2E
Pulse constant	E010 1111	2F
Digital input association	E011 0000	30
Digital input status	E011 0010	32
Overload alarm setup	E011 0100	34
Pickup setpoint	E011 0101	35
Digital output association with overload alarm	E011 0110	36
Activated status	E011 0111	37
Acknowledgement	E011 1000	38
Date and time of last alarm	E011 1001	39
Value at last alarm	E011 1010	3A

Telegram information for data records

The following sections outline the telegram information used in data records. The tables contain the following information (if applicable):

- Data format in hex (for example, 16-bit integer)
- Primary VIF in hex
- Primary VIFE codes in bin and hex
- Manufacturer-specific VIFE codes in bin and hex

Meter information

NOTE: E denotes the extension bit; the hex value assumes E = 0.

Data format	Primary VIF Extension		Description
	bin	hex	
0D	E000 1010	0A	Manufacturer 18-bit ASCII = Schneider Electric
0D	E000 1100	0C	Model
03	E0001 0111	17	Meter error codes: 0 = Code 101: EEPROM error 1 = Code 102: No calibration table 2 = Code 201: Mismatch between frequency settings and frequency measurements 3 = Code 202: Mismatch between wiring settings and wiring inputs 4 = Code 203: Phase sequence reversed 5 = Code 204: Total active energy negative due to incorrect voltage or current connections 6 = Code 205: Date and time are reset due to a power failure 7 = Code 206: Pulse missing due to overspeed of energy pulse output 8 = Code 207: Abnormal internal clock function 9 = Internal data bus communications error

Related topics

- See “Troubleshooting” on page 103 for more information on the diagnostics codes.

Energy and energy by tariff measurements

The energy and energy by tariff measurements listed below are preserved through power failures.

NOTE: E denotes the extension bit; the hex value assumes E = 0.

Data format	DIFE	Primary VIF	Primary VIFE		Manufacturer-specific VIFE		Description
			bin	hex	bin	hex	
07	—	03	—	—	—	—	Total active energy import
07	—	83	—	—	E000 1001	09	Total active energy export
87	40	03	—	—	—	—	Total reactive energy import
87	40	83	—	—	E000 1001	09	Total reactive energy export
07	—	83	—	—	E000 1101	0D	Partial active energy import
87	40	83	—	—	E000 1101	0D	Partial reactive energy import
07	—	83	—	—	E000 0001	01	Active energy import phase 1
07	—	83	—	—	E000 0010	02	Active energy import phase 2
07	—	83	—	—	E000 0011	03	Active energy import phase 3
03	—	—	—	—	E001 0000	10	Active tariff 0 = Multi Tariff feature is disabled 1 = rate A (tariff 1) active 2 = rate B (tariff 2) active 3 = rate C (tariff 3) active 4 = rate D (tariff 4) active
87	10	03	—	—	—	—	Rate A (tariff 1) active energy import
87	20	03	—	—	—	—	Rate B (tariff 2) active energy import
87	30	03	—	—	—	—	Rate C (tariff 3) active energy import

Data format	DIFE	Primary VIF	Primary VIFE		Manufacturer-specific VIFE		Description
			bin	hex	bin	hex	
87	80 10	03	—	—	—	—	Rate D (tariff 4) active energy import
07	—	—	E110 0001	61	—	—	Input metering accumulation
04	—	ED	—	—	E000 1100	0C	Date and time of last partial energy reset
04	—	ED	—	—	E000 1110	0E	Date and time of last input metering reset

Instantaneous measurements

NOTE: E denotes the extension bit; the hex value assumes E = 0.

Data format	DIFE	Primary VIF	Primary VIFE		Manufacturer-specific VIFE		Description
			bin	hex	bin	hex	
05	—	AE	—	—	E000 0001	01	Active power Phase 1
05	—	AE	—	—	E000 0010	02	Active power Phase 2
05	—	AE	—	—	E000 0011	03	Active power Phase 3
05	—	2E	—	—	—	—	Total active power
85	40	2E	—	—	—	—	Total reactive power
85	80 40	2E	—	—	—	—	Total apparent power
05	—	—	E100 1001	C9	E000 0001	01	Voltage L1-N
05	—	—	E100 1001	C9	E000 0010	02	Voltage L2-N
05	—	—	E100 1001	C9	E000 0011	03	Voltage L3-N
05	—	—	E100 1001	C9	E000 0100	04	Average voltage line-to-neutral
05	—	—	E100 1001	C9	E000 0101	05	Voltage L1-L2
05	—	—	E100 1001	C9	E000 0110	06	Voltage L2-L3
05	—	—	E100 1001	C9	E000 0111	07	Voltage L3-L1
05	—	—	E100 1001	C9	E000 1000	08	Average voltage line-to-line
05	—	—	E101 1100	DC	E000 0001	01	Phase 1 current
05	—	—	E101 1100	DC	E000 0010	02	Phase 2 current
05	—	—	E101 1100	DC	E000 0011	03	Phase 3 current
05	—	—	E101 1100	DC	E000 0000	00	Average current
05	—	—	—	—	E000 1010	0A	Total power factor
05	—	—	—	—	E000 1011	0B	Frequency

Meter status information

Use the following information to read system and status information from the meter. See the section regarding telegram information for meter configuration for more information on writing to the meter.

Date and time information

NOTE: E denotes the extension bit; the hex value assumes E = 0.

Data format	Primary VIF	Manufacturer-specific VIFE		Description
		bin	hex	
04	6D	—	—	Meter date and time (DD/MM/YYYY hh:mm:ss)
06	—	E010 0000	20	Meter operation timer: the time in seconds since the device was last powered up

Power system configuration information

NOTE: E denotes the extension bit; the hex value assumes E = 0.

Data format	Manufacturer-specific VIFE		Description
	bin	hex	
03	E010 0011	23	Power system configuration: 0 = 1PH2W L-N 1 = 1PH2W L-L 2 = 1PH3W L-L with N 3 = 3PH3W 11 = 3PH4W 13 = 1PH4 wire multi L with N
03	E010 0010	22	Number of wires 2, 3, 4
03	E010 0001	21	Number of phases 1, 3
03	E010 1000	29	Number of CTs 1, 2, 3 NOTE: only applies to the iEM3235
03	E010 0101	25	Number of VTs 0-10 NOTE: only applies to the iEM3235
05	E010 0110	26	VT Primary NOTE: only applies to the iEM3235
03	E010 0111	27	VT Secondary NOTE: only applies to the iEM3235
03	E010 1001	29	CT Primary NOTE: only applies to the iEM3235
03	E010 1010	2A	CT Secondary NOTE: only applies to the iEM3235
03	E010 1011	2B	VT connection type 0 = Direct connection, no VTs 1 = 3PH3W (2VTs) 2 = 3PH4W (3VTs)
03	E010 0100	24	Nominal frequency 50, 60

Digital input and output status information

NOTE: E denotes the extension bit; the hex value assumes E = 0.

Data format	Primary VIFE		Manufacturer-specific VIFE		Description
	bin	hex	bin	hex	
03	E001 1011	1B	—	—	Digital input control mode: 0 = Normal (Input Status) 2 = Multi Tariff control 3 = Input metering 5 = All partial energy logs reset
05	—	—	E010 1111	2F	Pulse constant (pulses/unit)
02	—	—	E011 0010	32	Digital input status: 0 = relay open 1 = relay closed NOTE: This information only applies if the digital input control mode is set to Input Status.
03	—	—	E011 0000	30	Digital input association with partial energy data reset 0 = Digital input is not associated with the partial energy reset 1 = Digital input is associated with the partial energy reset
03	—	—	E010 1100	2C	Energy pulse duration in milliseconds NOTE: This information only applies if the digital output mode is set to energy pulsing.

Data format	Primary VIFE		Manufacturer-specific VIFE		Description
	bin	hex	bin	hex	
05	—	—	E010 1110	2E	Pulse weight of the digital output NOTE: This information only applies if the digital output mode is set to energy pulsing.
03	E001 1010	1A	—	—	Digital output control mode 2 = for Alarm 3 = for Pulse (kWh) 0xFFFF = Disabled
03	—	—	E010 1101	2D	Digital output association with energy pulsing: 0 = Digital output disabled 1 = for Pulse (digital output is associated with active energy pulse output)
02	—	—	E011 0110	36	Digital output association with overload alarm: 0x0000 = digital output disabled 0x0100 = for Alarm (digital output is associated with the overload alarm)

Alarm status information

NOTE: E denotes the extension bit; the hex value assumes E = 0.

Data format	Primary VIF	Manufacturer-specific VIFE		Description
		bin	hex	
02	—	E011 0111	37	Alarm status: 0x0000 = Alarm is inactive 0x0100 = Alarm is active
02	—	E011 1000	38	Acknowledgement status: 0x0000 = historic alarm is acknowledged by the user 0x0100 = historic alarm is unacknowledged by the user
04	ED	E011 1001	39	Timestamp of last alarm (DD/MM/YYYY hh:mm:ss)
05	—	E011 1010	3A	Value at last alarm
02	—	E011 0100	34	Overload alarm configuration: 0x0000 = disabled 0x0100 = enabled
05	—	E011 0101	35	The pickup setpoint in kW for the overload alarm

Telegram information for meter configuration

You can use the information provided in this section to write to the meter using a SND_UD function.

NOTE: If Com. Protection is enabled, you may receive an error response when you try to configure the meter over communications.

You can also configure the meter using the M-Bus tool available from www.schneider-electric.com.

Supported VIFE codes for meter configuration

NOTE: E denotes the extension bit; the hex value assumes E = 0.

VIFE code		Action	Description
bin	hex		
E000 0000	00	Write and replace	Replaces the old value with the new value.
E000 0111	07	Clear	Resets an accumulated value to 0 (zero).

Related topics

- See “Configuration mode menus” on page 40 for information on enabling and disabling Com. Protection.
- See “M-Bus tool for data display and meter configuration” on page 85 for information on the M-Bus tool.

Date/time setup

Data format	Primary VIF	Description
04	6D	Type F data type, as described in the M-Bus protocol documentation. Supports the date and time in the following format YYYY:MM:DD hh:mm:ss.

Power system setup

NOTE: E denotes the extension bit; the hex value assumes E = 0.

SND_UD code	Data format	Manufacturer-specific VIFE		Range/options	Description
		bin	hex		
00	02	E010 0011	23	0, 1, 2, 3, 11, 13	Power system configuration: 0 = 1PH2W L-N 1 = 1PH2W L-L 2 = 1PH3W L-L with N 3 = 3PH3W 11 = 3PH4W 13 = 1PH4 wire multi L with N
00	02	E010 0100	24	50, 60	Nominal frequency
00	05	E010 0110	26	VT Secondary - 1000000.0	VT Primary (iEM3235 only)
00	02	E010 0111	27	100, 110, 115, 120	VT Secondary (iEM3235 only)
00	02	E010 1000	28	1, 2, 3	Number of CTs (iEM3235 only)
00	02	E010 1001	29	1-32767	CT Primary (iEM3235 only)
00	02	E010 1010	2A	1, 5	CT Secondary (iEM3235 only)
00	02	E010 1011	2B	0, 1, 2	VT Connection Type (iEM3235 only) 0 = direct connect 1 = 3PH3W (2 VTs) 2 = 3PH4W (3 VTs)

Multi Tariff setup

NOTE: E denotes the extension bit; the hex value assumes E = 0.

SND_UD code	Data format	Manufacturer-specific VIFE		Range/options	Description
		bin	hex		
00	02	E001 0001	11	0,1	Set Multi Tariff control mode to Disabled or by Communication: 0 = Disabled 1 = by Communication NOTE: To configure the Multi Tariff feature to be controlled by the digital input or device clock, use the HMI.
00	02	E001 0000	10	1, 2, 3, 4	Set the active tariff: 1 = Rate A (tariff 1) 2 = Rate B (tariff 2) 3 = Rate C (tariff 3) 4 = Rate D (tariff 4) NOTE: You can only set the tariff using this method if the Tariff Mode is set to by Communication.

Communications setup

SND_UD code	Data format	Primary VIF	Range/options	Description
00	01	7A	0-250	Primary address

To change the baud rate via communications, send a telegram to the meter with the appropriate value in the CI-field:

Baud rate	Hex value for CI-field
300	B8
600	B9
1200	BA
2400	BB
4800	BC
9600	BD

Digital input setup

NOTE: E denotes the extension bit; the hex value assumes E = 0.

SND_UD code	Data format	Manufacturer-specific VIFE		Range/options	Description
		bin	hex		
00	02	E001 1011	1B	0, 3, 5	Digital input control mode 0 = Normal (Input Status) 3 = Input metering 5 = Partial energy reset
00	05	E010 1111	2F	1-10000	Pulse constant (pulses/unit; applicable when the digital input is used for input metering)

Digital output setup

NOTE: E denotes the extension bit; the hex value assumes E = 0.

SND_UD code	Data format	Manufacturer-specific VIFE		Range/options	Description
		bin	hex		
00	02	E001 1010	1A	2, 3, 0xFFFF	Digital output control mode 2 = Alarm 3 = Energy (energy pulsing) 0xFFFF = Disable
00	05	E010 1110	2E	iEM3135 / iEM3335: 1, 10, 20, 100, 200, 1000 iEM3235: 0.01, 0.1, 1, 10, 100, 500	Pulse constant NOTE: This information only applies if the digital output control mode is set to for Pulse.
00	02	E010 1100	2C	50, 100, 200, 300	Pulse width in ms NOTE: This information only applies if the digital output control mode is set to for Pulse.

Overload alarm setup and acknowledgment

Use the information in the table below to configure the overload alarm.

NOTE: E denotes the extension bit; the hex value assumes E = 0.

SND_UD code	Data format	Manufacturer-specific VIFE		Range/options	Description
		bin	hex		
00	05	E011 0101	35	0 - 9999999	The pickup setpoint in kW for the overload alarm
00	02	E011 0100	34	0,1	Overload alarm setup: 0 = Disable 1 = Enable

Use the information in the table below to acknowledge the overload alarm.

NOTE: E denotes the extension bit; the hex value assumes E = 1.

SND_UD code	Data format	Manufacturer-specific VIFE		Range/options	Description
		bin	hex ¹		
07	00	E011 1000	B8	—	Acknowledge alarm

Resets

NOTE: E denotes the extension bit; the hex value assumes E = 1.

SND_UD code	Data format	Primary VIFE		Manufacturer-specific VIFE		Description
		bin	hex	bin	hex	
07	00	—	—	E000 1101	8D	Resets partial energy accumulation to 0.
07	00	E110 0001	E1	—	—	Resets input accumulation to 0.

M-Bus tool for data display and meter configuration

The M-Bus tool provides a graphical user interface where you can view meter data and configure meter settings. To obtain the tool, go to www.schneider-electric.com and search for your meter model then select Downloads or contact your local Schneider Electric representative.

If you access a different meter without closing and re-opening the M-Bus tool, the fields displayed in the tool may not match the device you are accessing. The M-Bus tool may indicate a setting was changed without the setting on the meter actually changing.

NOTICE
<p>INACCURATE DEVICE SETTINGS</p> <p>Do not rely on the configuration information displayed in the M-Bus tool to determine if the associated device is correctly configured.</p> <p>Failure to follow these instructions can result in inaccurate device settings and data results.</p>

Installing the M-Bus tool

Before you install the tool, you need to download it from www.schneider-electric.com or obtain it from your sales representative.

1. Navigate to the location where you saved the installation files.
2. Double-click setup.exe. A welcome screen appears. Click **Next**.
3. Confirm the installation location for the tool. Click **Browse** if you want to select a different location. Click **Next**. A confirmation screen appears.
4. Click **Next** to begin the installation. A screen appears when the installation is complete.
5. Click **Close**.

Accessing the meter using the tool

Before you access the meter using the M-Bus tool, make sure that you:

- connect the meter to a level converter (for a direct serial connection) or a level converter and gateway (for connection via a serial or Ethernet network).
 - set the address of the device to a value other than 0 (zero) using the HMI.
 - install the M-Bus tool on your computer.
1. Select **Start > Programs > Schneider Electric > Mbus config tool** (or navigate to the location where you installed the program) and click **SE_iEM3135_3235_3335 Mbus Tool** to open the tool. The login screen appears.

2. Select the port on your computer that you are using to connect to the meter and select the baud rate that matches the meter's configuration.
3. Click **Test Com** to open the communications port.
4. Type the device address in the **Address** field.
5. Select the communications mode that you want the tool to start in:
 - **Monitor(Automatic)**: The tool automatically sends read requests to and receives data from the meter. You can set the interval at which these read requests are sent.
 - **Monitor(Manual)**: You must manually send a read request to get data from the meter.
 - **Config**: The tool opens in configuration mode.

You can change the mode from within the tool, if needed.
6. Click **OK** to start the M-Bus tool and access the meter.

Viewing meter data using the M-Bus tool

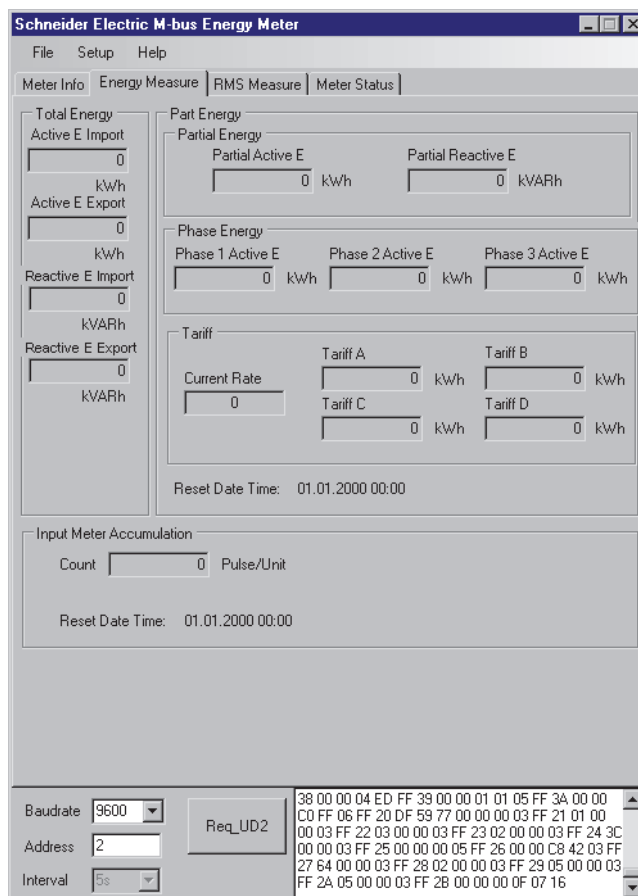

You can use two modes to view data from the device:

- Automatic mode: Select the update interval from the **Interval** dropdown list.
- Manual mode: Press **Req_UD2** to request data from the meter.

To switch modes, select **Setup > Monitor** then select the mode you want to use.

The tool has the following tabs for viewing meter information:

Tab name	Description
Meter Info	This tab provides basic information about the meter (for example, model and serial number) and any active error codes. Click Clear to remove the error codes from the display. This does not resolve the errors.
Energy Measure	This tab provides total and partial energy, energy per phase and energy by tariff information, as well as input accumulations and the date and time of the last input metering and partial energy resets.

Tab name	Description
RMS Measure	This tab provides power, current, and voltage values as well as frequency and power factor information.
Meter Status	This tab provides information on the settings and status of the digital input, digital outputs and alarms as well as existing power system settings.

Configuring the meter using the M-Bus tool

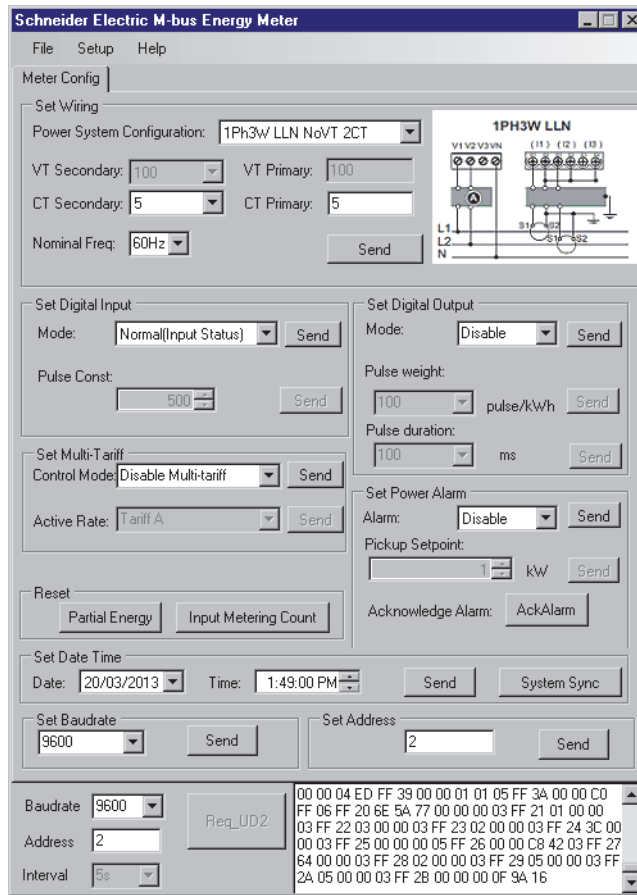

1. Select **Setup > Config** to switch to configuration mode.
2. Set the values that you want to change then click **Send** for that value or section. For example, to change the nominal frequency, select a different value from the list then click **Send** in **Set Wiring**.

Some values may be unavailable based on existing settings.

NOTE: If Com. Protection is enabled, you may receive a message that the configuration failed. Use the HMI to either: 1) configure the meter, or 2) disable Com. Protection then configure the meter using the tool.

The configuration screen has the following sections:

Section	Description
Set Wiring	Configure power system settings (for example, power system configuration and nominal frequency).
Set Digital Input	Set the digital input mode and pulse constant.
Set Digital Output	Enable / disable the digital output and set the control mode, pulse weight and duration.
Set Multi Tariff	Disable the Multi Tariff feature or set the control mode to by Communication and set the active tariff if the control mode is set to by Communication.
Set Power Alarm	Enable / disable to the overload alarm, enter the setpoint, and acknowledge alarms.
Reset	Reset partial energy and input metering accumulations.
Set Date Time	Set the date and time or send a time synchronization signal to set the meter to the computer time.
Set Baudrate	Set the baud rate.
Set Address	Set the meter address.

Chapter 8 Communications via BACnet

What is in this chapter?

This chapter contains the following sections:

- BACnet communications overview** 89
- BACnet protocol support** 89
- BACnet communications implementation** 90
- BACnet object and property information** 91

BACnet communications overview

Communications via BACnet MS/TP protocol is available on the iEM3165, iEM3265 and iEM3365.

The information in this section is intended for users with an advanced understanding of BACnet protocol, their communications network and their power system.

Key terms

Term	Definition
APDU	Application protocol data unit, that data portion of a BACnet message.
Confirmed message	A message for which the device expects an answer.
COV	Change of value, sets the amount by which a value has to change in order for the meter to send a subscription notification.
Device	A BACnet device is a unit that is designed to understand and use BACnet protocol (for example, a BACnet-enabled meter or software program). It contains information about the device and device data in objects and object properties. Your meter is a BACnet device.
MS/TP	Master-slave/token-passing over RS-485.
Object	Represents the device and device data. Each object has a type (for example, analog input or binary input) and has a number of properties.
Present value	The current value of an object.
Property	The smallest piece of information in BACnet communications, it consists of a name, data type and value.
Service	Messages from one BACnet device to another.
Subscription	Creates a relationship between the server and the meter, so that when the present value property of an object changes by more than the configured COV threshold (COV_Increment), a notification is sent.
Subscription notification	The message the meter sends to indicate a COV event has occurred.
Unconfirmed message	A message for which the device does not expect an answer.

Related topics

- See www.bacnet.org for more information on the BACnet protocol.

BACnet protocol support

Go to www.schneider-electric.com and search for your meter model to access the PICS (Protocol Implementation Conformance Statement) for your meter.

The meter supports the BACnet protocol as follows:

BACnet component	Description
Protocol version	1
Protocol revision	6
Standardized device profile (Annex L)	BACnet Application Specific Controller (B-ASC)

BACnet component	Description
BACnet Interoperability Building Blocks (Annex K)	DS-RP-B (Data Sharing - Read Property - B)
	DS-RPM-B (Data Sharing - Read Property Multiple - B)
	DS-WP-B (Data Sharing - Write Property - B)
	DS-COV-B (Data Sharing - COV - B)
	DM-DDB-B (Device Management - Dynamic Device Binding - B)
	DM-DOB-B (Device Management - Dynamic Object Binding - B)
	DM-DCC-B (Device Management - Device Communication Control - B)
Data link layer options	MS/TP master (clause 9) Baud rates 9600, 19200, 38400, 57600, 76800
Character set	ANSI X3.4
Supported services	subscribeCOV readProperty readPropertyMultiple writeProperty deviceCommunicationControl who-HAS who-Is I-Am I-Have Confirmed COV notification Unconfirmed COV notification
Segmentation	The meter does not support segmentation
Static device address binding	The meter does not support static device address binding
Networking options	None

The following standard object types are supported:

Object type	Optional properties supported	Writable properties supported	Proprietary properties
Device Object	Max_Master Max_Info_Frames Description Location Local_Date Local_Time Active_COV_Subscriptions Profile Name	Object_Name Max_Master Max_Info_Frames Description Location APDU_Timeout Number_Of_APDU_Retries	ID_800 ID_801 ID_802
Analog Input Object	COV_Increment	COV_Increment	—
Analog Value Object	—	Present_Value	—
Binary Input Object	—	—	—

Related topics

- See “Device object” on page 91 for information on the proprietary properties in the Device object.

BACnet communications implementation

Configuring basic communication parameters

Before communicating with the meter via BACnet protocol, use the front panel to configure the following settings:

Setting	Possible values
Baud rate	9600 19200 38400 57600 76800
Mac Address	1 - 127
Device ID	0 - 4194303

Make sure that the Mac Address is unique on the serial loop and the Device ID is unique in your BACnet network.

Communications LED indicator for BACnet meters

The LED indicates the status of the meter’s communications with the network.

LED state	Description
The LED is off	Communication is not active.
The LED is flashing	Communication is active. NOTE: The LED flashes even if there is a communications error.

Change of Value (COV) subscriptions

The meter supports up to 14 COV subscriptions. You can add COV subscriptions to Analog Input and Binary Input objects using your BACnet-compatible software.

Related topics

- See “Hardware overview” on page 16 for the location of the communications LED.
- See “Device configuration” on page 38 for information on configuring the meter using the front panel.

BACnet object and property information

The following sections outline the supported objects and properties available on the meter.

Device object

The following table outlines the properties of the Device object, whether a property is read-only or read-write, and if the value of the property is stored in the meter’s non-volatile onboard memory.

Device object property	R/W	Stored	Possible values	Description
Object_Identifier	R	—	configurable	The unique device ID number for the meter, in the format of <device, #>. NOTE: You must use the front panel to configure the device ID number.
Object_Name	R/W	√	configurable	A configurable name for the meter. The meter ships from the factory with a name of <model name>_<serial number> (for example, iEM3265_0000000000).
Object_Type	R	—	Device	The object type for the meter
System_Status	R	—	Operational	This value of this property is always Operational.
Vendor_Name	R	—	Schneider Electric	Meter manufacturer
Vendor_Identifier	R	—	10	The BACnet vendor identifier for Schneider Electric
Model_Name	R	—	iEM3165, iEM3265, iEM3365	Device model (for example, iEM3265) and serial number in the format <model name>_<serial number> (for example, iEM3265_0000000000).
Firmware_Revision	R	—	varies	BACnet firmware version, stored in an x.x.x format (for example, 1.7.2).
Application_Software_Version	R	—	varies	Meter firmware version, stored in an x.x.xxx format (for example, 1.0.305).
Description	R/W	√	configurable	Optional description of the meter, limited to 64 characters.
Location	R/W	√	configurable	Optional description of the meter’s location, limited to 64 characters.
Protocol_Version	R	—	varies	BACnet protocol version (for example, version 1)
Protocol_Revision	R	—	varies	BACnet protocol revision (for example, revision 6)
Protocol_Services_Supported	R	—	0000 0100 0000 1011 0100 0000 0000 0000 0110 0000	The BACnet services supported by the meter: subscribeCOV, readProperty, readPropertyMultiple, writeProperty, deviceCommunicationControl, who-HAS, who-Is
Protocol_Object_Types_Supported	R	—	1011 0000 1000 0000 0000 0000 0000 0000	The BACnet object types supported by the meter: analog input, analog value, binary input, device
Object_list	R	—	varies	List of objects in the meter: iEM3165 / iEM3365: DE1, AI0-AI48, AV0, BI0-BI6 iEM3265: DE1, AI0-AI55, AV0, BI0-BI6
Max_APDU_Length_Accepted	R	—	480	The maximum packet size (or application protocol data unit) that the meter can accept, in bytes
Segmentation_Supported	R	—	0x03	The meter does not support segmentation.
Local_Date	R	—	configurable	Date NOTE: You must use the front panel to set the meter’s date.

Device object property	R/W	Stored	Possible values	Description
Local_Time	R	—	configurable	Time NOTE: You must use the front panel to set the meter's time.
APDU_Timeout	R/W	√	1000 - 30000	The amount of time (in milliseconds) before the meter tries to resend a confirmed message that has not been answered.
Number_Of_APDU_Retries	R/W	√	1 - 10	The number of times the meter tries to resend an unanswered confirmed request.
Max_Master	R/W	√	1 - 127	The highest master address the meter will try to discover when the next node is unknown.
Max_Info_Frames	R/W	√	1 - 14	Maximum number of messages the meter can send before it must pass the token.
Device_Address_Binding	R	—	—	Device address binding table is always blank because the meter does not initiate the who-Is service.
Database_Revision	R	√	varies	A number that increments when the object database on the meter changes (for example, when an object is created or deleted or the ID of an object changes).
Active_COV_Subscriptions	R	—	varies	List of COV subscriptions currently active on the meter.
Profile_Name	R	—	varies	Device identifier, used on these meters to record the meter manufacturer, the meter family and the specific meter model (for example, 10_iEM3000_iEM3265).
ID 800	R	—	varies	Date and time of last energy reset
ID 801	R	—	varies	Date and time of last input metering accumulation reset
ID 802	R	—	varies	Date and time of the last alarm (DD/MM/YYYY hh:mm:ss)

Related topics

- See “Device configuration” on page 38 for information on configuring the meter using the front panel.

Analog Input objects

The following tables list the Analog Input (AI) objects along with the units and default COV value for each AI object (if applicable).

NOTE: The Value Type for all AI objects is Real.

Energy and energy by tariff measurements

The energy and energy by tariff measurements listed below are preserved through power failures.

Object ID	Units	Default COV	Object name / description
27	Wh	100	AI27 - Total active energy import
28	Wh	100	AI28 - Total active energy export
29	Wh	100	AI29 - Total reactive energy import
30	Wh	100	AI30 - Total reactive energy export
31	Wh	100	AI31 - Partial active energy import
32	Wh	100	AI32 - Partial reactive energy import
33	Wh	100	AI33 - Active energy import phase 1
34	Wh	100	AI34 - Active energy import phase 2
35	Wh	100	AI35 - Active energy import phase 3
36	—	10	AI36 - Accumulation Input metering accumulation
37	—	1	AI37 - Tariff Energy Active Rate Denotes the active tariff: 0 = Multi Tariff feature is disabled 1 = rate A (tariff 1) active 2 = rate B (tariff 2) active 3 = rate C (tariff 3) active 4 = rate D (tariff 4) active
38	Wh	100	AI38 - Rate A (Tariff 1) active energy import
39	Wh	100	AI39 - Rate B (Tariff 2) active energy import
40	Wh	100	AI40 - Rate C (Tariff 3) active energy import
41	Wh	100	AI41 - Rate D (Tariff 4) active energy import

Instantaneous (RMS) measurements

Object ID	Units	Default COV	Object name / description
7	A	50	AI07 - Current Phase 1
8	A	50	AI08 - Current Phase 2
9	A	50	AI09 - Current Phase 3
10	A	50	AI10 - Current Average
11	V	10	AI11 - Voltage L1-L2
12	V	10	AI12 - Voltage L2-L3
13	V	10	AI13 - Voltage L3-L1
14	V	10	AI14 - Voltage Average L-L
15	V	10	AI15 - Voltage L1-N
16	V	10	AI16 - Voltage L2-N
17	V	10	AI17 - Voltage L3-N
18	V	10	AI18 - Voltage Average L-N
19	kW	10	AI19 - Active Power Phase 1
20	kW	10	AI20 - Active Power Phase 2
21	kW	10	AI21 - Active Power Phase 3
22	kW	10	AI22 - Active Power Total
23	kVAR	10	AI23 - Reactive Power Total
24	kVA	10	AI24 - Apparent Power Total
25	—	0.2	AI25 - Power Factor Total
26	Hz	10	AI26 - Frequency

Meter information

The following AI objects display information about the meter and its configuration.

NOTE: You can access the meter’s configuration information over BACnet communications. However, you must use the front panel to configure the meter’s settings.

Object ID	Units	Default COV	Object name / description
44	Seconds	10	AI44 - Meter operation time The time in seconds since the meter was last powered up
45	—	1	AI45 - Number of phases 1, 3
46	—	1	AI46 - Number of wires 2, 3, 4
47	—	1	AI47 - Power system type 0 = 1PH2W L-N 1 = 1PH2W L-L 2 = 1PH3W L-L with N 3 = 3PH3W 11 = 3PH4W 13 = 1PH4 wire multi L-N
48	Hz	1	AI48 - Nominal frequency 50, 60
49	—	1	AI49 - Number of VTs 0 - 10 NOTE: only applies to the iEM3265
50	V	1	AI50 - VT Primary NOTE: only applies to the iEM3265
51	V	1	AI51 - VT Secondary NOTE: only applies to the iEM3265
52	—	1	AI52 - Number of CTs 1, 2, 3 NOTE: only applies to the iEM3265
53	A	1	AI53 - CT Primary NOTE: only applies to the iEM3265

Object ID	Units	Default COV	Object name / description
54	A	1	AI54 - CT Secondary NOTE: only applies to the iEM3265
55	—	1	AI55 - VT connection type 0 = Direct connection, not VTs 1 = 3PH3W (2VTs) 2 = 3PH4W (3VTs)

Communications settings information

The following AI objects display information about the meter’s communications settings.

NOTE: You can access the meter’s communications configuration information over BACnet communications. However, you must use the front panel to configure the meter’s settings.

Object ID	Units	Default COV	Object name / description
00	—	1	AI00 - BACnet MAC Address
01	—	1	AI01 - BACnet Baud Rate

Digital input and output setting information

The following AI objects display information about the meter’s I/O settings.

NOTE: You can access the meter’s I/O configuration information over BACnet communications. However, you must use the front panel to configure the meter’s settings.

Object ID	Units	Default COV	Object name / description
02	ms	1	AI02 - Pulse Duration The energy pulse duration (or pulse width), in milliseconds, of the digital output. NOTE: This information only applies if the digital output mode is set to energy pulsing.
03	—	1	AI03 - Pulse Weight The pulses/unit setting of the digital input when it is configured for input metering. NOTE: This information only applies if the digital input mode is set to Input Metering.
04	—	1	AI04 - Pulse Constant The pulses/kWh setting of the digital output. NOTE: This information only applies if the digital output mode is set to energy pulsing.
05	—	1	AI05 - Digital Input Mode 0 = Normal (input status) 2 = Multi Tariff control 3 = Input metering 5 = All partial energy logs reset
06	—	1	AI06 - Digital Output Mode 2 = Alarm 3 = Energy 0xFFFF (65535 dec) = Disabled
42	kW	10	AI42 - Pickup Setpoint Active power alarm pickup setpoint in kW
43	kW	10	AI43 - Last Alarm Value

Related topics

- See “Device configuration” on page 38 for information on configuring the meter using the front panel.
- See “Binary Input objects” on page 95 for information on reading the statuses of the input, output and alarm.

Analog Value object

There is one Analog Value (AV) object available on the meter, named AV00 - Command. The available commands are listed in the following table. Enter the number in the Present_Value column in the Present_Value property of the AV object to write the associated command to the meter.

Command	Present_Value entry	Object name / description
Acknowledge Overload Alarm	20001.00	Acknowledge an overload alarm. The alarm indicator disappears from the front panel display after you acknowledge the alarm; however, this does not address the state that caused the alarm.
Reset Partial Energy Counter	2020.00	Reset partial energy accumulation to 0. Partial Active / Reactive Energy, Energy by Tariff and Phase Energy registers are reset.
Reset Input Metering Counter	2023.00	Resets input metering accumulation to 0.

Binary Input objects

The following table lists the Binary Input (BI) objects available on the meter.

NOTE: The Value Type for all BI objects is Boolean.

Object ID	Object name / description
0	BI00 - Digital Output Enable Indicates whether or not the digital output functions as an energy pulse output: 0 = Digital output disabled 1 = Digital output is associated with active energy pulse output
1	BI01 - Digital Input Association Enable Indicates whether or not the digital input is associated with input metering: 0 = Digital input is not associated with input metering. 1 = Digital input is associated with input metering.
2	BI02 - Digital Input Status 0 = relay open 1 = relay closed NOTE: This information only applies if the digital input is set to Input Status.
3	BI03 - Alarm Enable Indicates whether the overload alarm is enabled or disabled: 0 = disabled 1 = enabled
4	BI04 - Digital Output Association Enable Indicates if the digital output is configured for alarming: 0 = digital output disabled 1 = for Alarm (digital output is associated with the overload alarm)
5	BI05 - Alarm Status 0 = Alarm is inactive 1 = Alarm is active
6	BI06 - Unacknowledged status 0 = historic alarm is acknowledged 1 = historic alarm is unacknowledged

Chapter 9 Specifications

What is in this chapter?

This chapter contains the following sections:

- Electrical characteristics** 97
- Mechanical characteristics** 99
- Environmental characteristics** 99
- Measurement accuracy** 99
- MID** 100
- Internal clock** 100
- Modbus communications** 100
- LonWorks communications** 100
- M-Bus communications** 101
- BACnet communications** 101

Electrical characteristics

Power system inputs: iEM31•• meters

Characteristic	Value
Measured voltage	Wye: 100 - 277 V L-N, 173 - 480 V L-L $\pm 20\%$ Delta: 173 - 480 V L-L $\pm 20\%$
Maximum current	63 A
Measured current	0.5 A to 63 A
Overload	332 V L-N or 575 V L-L
Voltage impedance	3 M Ω
Current impedance	< 0.3 m Ω
Frequency	50 / 60 Hz $\pm 10\%$
Measurement category	III
Minimum wire temperature rating required	90 °C (194 °F)
Burden	< 10 VA at 63 A
Wire	16 mm ² / 6 AWG
Wire strip length	11 mm / 0.43 in
Torque	1.8 Nm / 15.9 in•lb

Power system inputs: iEM33•• meters

Characteristic	Value
Measured voltage	Wye: 100 - 277 V L-N, 173 - 480 V L-L $\pm 20\%$ Delta: 173 - 480 V L-L $\pm 20\%$
Maximum current	125 A
Measured current	1 A to 125 A
Overload	332 V L-N or 575 V L-L
Voltage impedance	6 M Ω
Current impedance	< 0.2 m Ω
Frequency	50 / 60 Hz $\pm 10\%$
Measurement category	III
Minimum wire temperature rating required	105 °C (221 °F)
Burden	< 10 VA at 125 A
Wire	50 mm ² / 1 AWG
Wire strip length	13 mm / 0.5 in
Torque	3.5 Nm / 30.9 in•lb

Power system inputs: iEM32•• meters

	Characteristic	Value
Voltage inputs	Measured voltage	Wye: 100 - 277 V L-N, 173 - 480 V L-L ±20% Delta: 173 - 480 V L-L ±20%
	Overload	332 V L-N or 575 V L-L
	Impedance	3 MΩ
	Frequency	50 / 60 Hz ±10%
	Measurement category	III
	Minimum wire temperature rating required	90 °C (194 °F)
	Maximum device consumption	< 10 VA
	Wire	2.5 mm ² / 14 AWG
	Wire strip length	8 mm / 0.31 in
	Torque	0.5 Nm / 4.4 in•lb
Current inputs	Nominal current	1 A or 5 A
	Measured current	20 mA to 6 A
	Withstand	10 A continuous, 20 A at 10 sec/hr
	Minimum wire temperature rating required	90 °C (194 °F)
	Impedance	< 1 mΩ
	Frequency	50 / 60 Hz ±10%
	Burden	< 0.036 VA at 6 A
	Wire	6 mm ² / 10 AWG
	Wire strip length	8 mm / 0.31 in
	Torque	0.8 Nm / 7.0 in•lb

Inputs and outputs

	Characteristic	Value	Meters
Programmable digital output	Number	1	iEM3135 / iEM3155 / iEM3165 / iEM3235/ iEM3255 / iEM3265 / iEM3335 / iEM3355 / iEM3365
	Type	Form A	
	Load voltage	5 – 40 V DC	
	Maximum load current	50 mA	
	Output resistance	0.1 – 50 Ω	
	Isolation	3.75 kV rms	
	Wire	1.5 mm ² / 16 AWG	
	Wire strip length	6 mm / 0.23 in	
	Torque	0.5 Nm / 4.4 in•lb	
	Pulse output	Number	
Type		S0 form (IEC 62053-31 compatible)	
Pulses / kWh		Configurable	
Voltage		5 – 30 V DC	
Current		1 – 15 mA	
Pulse width		Configurable Minimum width is 50 ms	
Isolation		3.75 kV rms	
Wire		2.5 mm ² / 14 AWG	
Wire strip length		7 mm / 0.28 in	
Torque		0.5 Nm / 4.4 in•lb	

Characteristic		Value	Meters	
Programmable digital input	Number	2	iEM3115 / iEM3215	
		1	iEM3135 / iEM3155 / iEM3165 / iEM3175 / iEM3235 / iEM3255 / iEM3265 / iEM3275 / iEM3335 / iEM3355 / iEM3365 / iEM3375	
	Type	Type 1 (IEC 61131-2)	iEM3115 / iEM3135 / iEM3155 / iEM3165 / iEM3175 / iEM3215 / iEM3235 / iEM3255 / iEM3265 / iEM3275 / iEM3335 / iEM3355 / iEM3365 / iEM3375	
	Maximum input	Voltage		40 V DC
		Current		4 mA
	Voltage OFF	0 - 5 V DC		
	Voltage ON	11 - 40 V DC		
	Nominal voltage	24 V DC		
	Isolation	3.75 kV rms		
	Wire	1.5 mm ² / 16 AWG		
	Wire strip length	6 mm / 0.23 in		
	Torque	0.5 Nm / 4.4 in•lb		

Mechanical characteristics

Characteristic	Value		Meters
IP degree of protection	Front panel	IP40	iEM31** / iEM32** / iEM33**
	Meter body	IP20	
Impact rating	IK08		iEM31** / iEM32** / iEM33**
Active energy display range	In kWh or MWh up to 99999999 MWh		iEM32**
	In kWh: 8 + 1 digits up to 99999999.9		iEM31** / iEM33**
Energy pulsing LED (yellow) ¹	500 flashes / kWh		iEM31**
	5000 flashes / kWh without consideration of transformer ratios		iEM32**
	200 flashes / kWh		iEM33**

¹The pulses / kWh of the energy pulsing LED cannot be changed.

Environmental characteristics

Characteristic	Value	Meters
Operating temperature	-25 °C (-13 °F) to +55 °C (131 °F) (K55)	iEM31** / iEM32** / iEM33**
Storage temperature	-40 °C (-40 °F) to +85 °C (185 °F)	
Pollution degree	2	
Relative humidity	5% – 95% RH non-condensing Maximum dewpoint 50 °C (122 °F)	
Location	For indoor use only Not suitable for wet locations	
Altitude	< 2000 m (6561 ft) above sea level	

Measurement accuracy

Characteristic	Value	Meters
63 A	Class 1 conforming to IEC 62053-21 and IEC 61557-12 (PMD DD): $I_{max}=63\text{ A}$, $I_b=10\text{ A}$, and $I_{st}=0.04\text{ A}$	iEM31**
	Class B conforming to EN 50470-3: $I_{max}=63\text{ A}$, $I_{ref}=10\text{ A}$, $I_{min}=0.5\text{ A}$, and $I_{st}=0.04\text{ A}$	iEM31**
	Class 2 conforming to IEC 62053-23 and IEC 61557-12 (PMD DD): $I_{max}=63\text{ A}$, $I_b=10\text{ A}$, and $I_{st}=0.05\text{ A}$	iEM3135 / iEM3155 / iEM3165 / iEM3175
125 A	Class 1 conforming to IEC 62053-21 and IEC 61557-12 (PMD DD): $I_{max}=125\text{ A}$, $I_b=20\text{ A}$, and $I_{st}=0.08\text{ A}$	iEM33**
	Class B conforming to EN 50470-3: $I_{max}=125\text{ A}$, $I_{ref}=20\text{ A}$, $I_{min}=1\text{ A}$, and $I_{st}=0.08\text{ A}$	iEM33**
	Class 2 conforming to IEC 62053-23 and IEC 61557-12 (PMD DD): $I_{max}=125\text{ A}$, $I_b=20\text{ A}$, and $I_{st}=0.1\text{ A}$	iEM3335 / iEM3355 / iEM3365 / iEM3375

Characteristic		Value	Meters
for x/1A current input	Active energy	Class 1 conforming to IEC 62053-21 and IEC 61557-12 (PMD SD): $I_{max}=1.2$ A, $I_n=1$ A, and $I_{st}=0.002$ A	iEM3200 / iEM3210 / iEM3215
		Class 1 conforming to IEC 62053-21 and IEC 61557-12 (PMD Sx): $I_{max}=1.2$ A, $I_n=1$ A, and $I_{st}=0.002$ A	iEM3235 / iEM3250 / iEM3255 / iEM3265 / iEM3275
		Class B conforming to EN 50470-3: $I_{max}=1.2$ A, $I_n=1$ A, $I_{min}=0.01$ A, and $I_{st}=0.002$ A	iEM32**
Reactive energy	Class 2 conforming to IEC 62053-23 and IEC 61557-12 (PMD Sx): $I_{max}=1.2$ A, $I_n=1$ A, and $I_{st}=0.003$ A	iEM3235 / iEM3255 / iEM3265 / iEM3275	
for x/5A current input	Active energy	Class 0.5S conforming to IEC 62053-22 and IEC 61557-12 (PMD SD): $I_{max}=6$ A, $I_n=5$ A, and $I_{st}=0.005$ A	iEM32**
		Class 0.5S conforming to IEC 62053-22 and IEC 61557-12 (PMD Sx): $I_{max}=6$ A, $I_n=5$ A, and $I_{st}=0.005$ A	iEM3235 / iEM3250 / iEM3255 / iEM3265 / iEM3275
		Class C conforming to EN 50470-3: $I_{max}=6$ A, $I_n=5$ A, $I_{min}=0.05$ A, and $I_{st}=0.005$ A	iEM32**
Reactive energy	Class 2 conforming to IEC 62053-23 and IEC 61557-12 (PMD Sx): $I_{max}=6$ A, $I_n=5$ A, and $I_{st}=0.015$ A	iEM3235 / iEM3255 / iEM3265 / iEM3275	

MID

Characteristic	Value	Meters
Electromagnetic environmental class	E2	iEM3110 / iEM3115 / iEM3135 / iEM3155 / iEM3165 / iEM3175 / iEM3210 / iEM3215 / iEM3235 / iEM3255 / iEM3265 / iEM3275 / iEM3310 / iEM3335 / iEM3355 / iEM3365 / iEM3375
Mechanical environmental class	M1	

Complies with the European Measuring Instruments Directive (MID) 2004/22/CE when installed in a suitable switchboard in accordance with the instructions in DOCA0038EN, available on our website. The CE declaration document is also available; search for ECDiEM3000.

Internal clock

Characteristic	Value	Meters
Type	Quartz crystal based Backup by supercapacitor	iEM3115 / iEM3135 / iEM3155 / iEM3165 / iEM3175 / iEM3215 / iEM3235 / iEM3255 / iEM3265 / iEM3275 / iEM3335 / iEM3355 / iEM3365 / iEM3375
Time error	< 2.5 s/day (30 ppm) at 25°C (77°F)	
Backup time	> 3 days at 25°C (77°F)	

Modbus communications

Characteristic	Value	Meters
Number of ports	1	iEM3150 / iEM3155 / iEM3250 / iEM3255 / iEM3350 / iEM3355
Labels	0V, D0/-, D1/+ ⊕ (shield)	
Parity	Even, Odd, None	
Baud rate	9600, 19200, 38400	
Isolation	4.0 kV rms	
Wire	2.5 mm ² / 14 AWG shielded twisted pair	
Wire strip length	7 mm / 0.28 in	
Torque	0.5 Nm / 4.4 in•lb	

Related topics

- See “Communications via Modbus RS-485” on page 51 for information on Modbus communications.

LonWorks communications

Characteristic	Value	Meters
Number of ports	1	iEM3175 / iEM3275 / iEM3375
Isolation	3.75 kV rms	
Wire	2.5 mm ² / 14 AWG	
Wire strip length	7 mm / 0.28 in	
Torque	0.5 Nm / 4.4 in•lb	

Related topics

- See “Communications via LonWorks” on page 63 for information on LonWorks communications.

M-Bus communications

Characteristic	Value	Meters
Number of ports	1	iEM3135 / iEM3235 / iEM3335
Parity	Even, Odd, None	
Baud rate	300, 600, 1200, 2400, 4800, 9600	
Isolation	3.75 kV rms	
Wire	2.5mm ² / 14 AWG	
Wire strip length	7 mm / 0.28 in	
Torque	0.5 Nm / 4.4 in•lb	

Related topics

- See “Communications via M-Bus” on page 75 for information on M-Bus communications.

BACnet communications

Characteristic	Value	Meters
Number of ports	1	iEM3165 / iEM3265 / iEM3365
Labels	0V, D0/-, D1/+ \oplus (shield)	
Baud rate	9600, 19200, 38400, 57600, 76800	
Isolation	4.0 kV rms	
Wire	2.5mm ² / 14 AWG shielded twisted pair	
Wire strip length	7 mm / 0.28 in	
Torque	0.5 Nm / 4.4 in•lb	

Related topics

- See “Communications via BACnet” on page 89 for information on BACnet communications.

Chapter 10 Troubleshooting

The meter does not contain any user-serviceable parts. If the meter requires service, contact your local Schneider Electric representative.

NOTICE
<p>RISK OF DAMAGE TO THE METER</p> <ul style="list-style-type: none"> • Do not open the meter case. • Do not attempt to repair any components of the meter. <p>Failure to follow these instructions can result in equipment damage.</p>

Do not open the meter. Opening the meter voids the warranty.

Diagnosis screen

The Diagnosis screen lists any current diagnostic codes.

NOTE: The Diagnosis screen only appears if there is a specific event.

<div style="border: 1px solid gray; padding: 5px; display: inline-block;"> <p>Diagnosis</p> <p style="text-align: right;">201</p> <hr/> <p>T1 23-Apr-2012 1/2</p> </div> <div style="margin-left: 20px;"> <p>Ⓐ</p> <p>Ⓑ</p> </div>	<table border="1" style="width: 100%; border-collapse: collapse;"> <tr> <td style="width: 20px; text-align: center;">A</td> <td>Diagnostic code</td> </tr> <tr> <td style="text-align: center;">B</td> <td>Existing events</td> </tr> </table>	A	Diagnostic code	B	Existing events
A	Diagnostic code				
B	Existing events				

1. Press the down button to scroll through the main display screens until you reach the **Diagnosis** screen.
2. Press the button to scroll through any existing events.

Related topics

- See “Data display” on page 33 for more information on navigating to the Diagnosis screen.

Diagnostic codes

If the diagnostics code persists after following the instructions below, please contact Technical Support.

Diagnostic code ¹	Description	Possible solution
–	LCD display is not visible.	Check and adjust LCD contrast.
–	Push buttons do not respond.	Restart the meter by powering off and powering on again.
101	Metering stops due to an EEPROM error. Press OK to display total energy consumption.	Enter configuration mode and select Reset Config .
102	Metering stops due to a lack of a calibration table. Press OK to display total energy consumption.	Enter configuration mode and select Reset Config .
201	Metering continues. Mismatch between frequency settings and frequency measurements.	Correct the frequency settings according to the nominal frequency of the power system.
202	Metering continues. Mismatch between wiring settings and wiring inputs.	Correct the wiring settings according to wiring inputs.
203	Metering continues. Phase sequence reversed.	Check the wire connections and correct the wiring settings if needed.
204	Metering continues. Total active energy is negative due to incorrect voltage and current connections.	Check the wire connections and correct the wiring settings if needed.
205	Metering continues. Date and Time have been reset due to a loss of power.	Set the Date and Time.
206	Metering continues. Pulse is missing due to overload on energy pulse output.	Check the energy pulse output settings and correct if needed.
207	Metering continues. Abnormal internal clock function.	Restart the meter by powering off and powering on again then reset the date and time.

¹ Not all diagnostic codes apply to all devices.

Chapter 11 Power, energy and power factor

NOTE: The descriptions in this section assume that you are an electrical energy consumer, not a supplier.

What is in this chapter?

This chapter contains the following sections:

- Power (PQS) 105**
- Energy delivered (imported) / energy received (exported) 106**
- Power factor (PF) 106**
- Power factor register format 108**

Power (PQS)

A typical AC electrical system load has both resistive and reactive (inductive or capacitive) components. Resistive loads consume real power (P) and reactive loads consume reactive power (Q).

Apparent power (S) is the vector sum of real power (P) and reactive power (Q):

$$S = \sqrt{P^2 + Q^2}$$

Real power is measured in watts (W or kW), reactive power is measured in vars (VAR or kVAR) and apparent power is measured in volt-amperes (VA or kVA).

Power and the PQ coordinate system

The meter uses the values of real power (P) and reactive power (Q) on the PQ coordinate system to calculate apparent power.

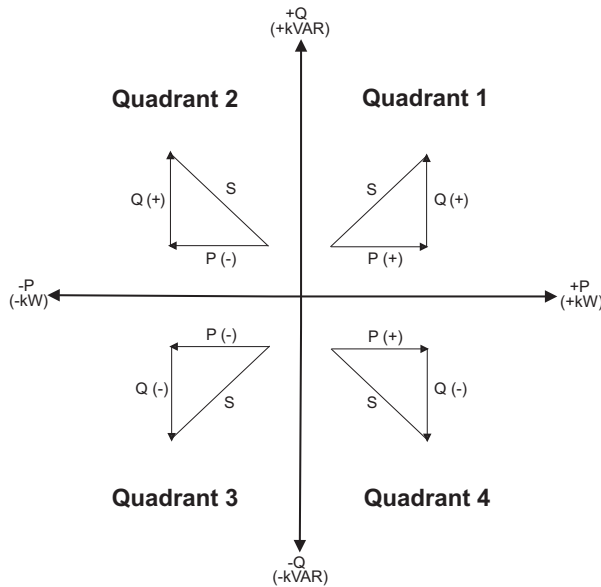

Power flow

Positive power flow P(+) and Q(+) means power is flowing from the power source towards the load. Negative power flow P(-) and Q(-) means power is flowing from the load towards the power source.

Energy delivered (imported) / energy received (exported)

The meter interprets energy delivered (imported) or received (exported) according to the direction of real power (P) flow.

Energy delivered (imported) means positive real power flow (+P) and energy received (exported) means negative real power flow (-P).

Quadrant	Real (P) power flow	Energy delivered (imported) or received (exported)
Quadrant 1	Positive (+)	Energy delivered (imported)
Quadrant 2	Negative (-)	Energy received (exported)
Quadrant 3	Negative (-)	Energy received (exported)
Quadrant 4	Positive (+)	Energy delivered (imported)

Power factor (PF)

Power factor (PF) is the ratio of real power (P) to apparent power (S), and is a number between 0 and 1.

$$PF = \frac{P}{S}$$

An ideal, purely resistive load has no reactive components, so its power factor is one (PF = 1, or unity power factor). A purely inductive or capacitive load no resistive components, so its power factor is zero (PF = 0).

True PF and displacement PF

The meter supports true power factor and displacement power factor values:

- True power factor includes harmonic content.
- Displacement power factor only considers the fundamental frequency.

PF lead / lag convention

The meter correlates leading power factor (PF lead) or lagging power factor (PF lag) with whether the current waveform is leading or lagging the voltage waveform.

Current phase shift from voltage

For purely resistive loads the current waveform is in phase with the voltage waveform. For capacitive loads, current leads voltage. For inductive loads, current lags voltage.

Current lead / lag and load type

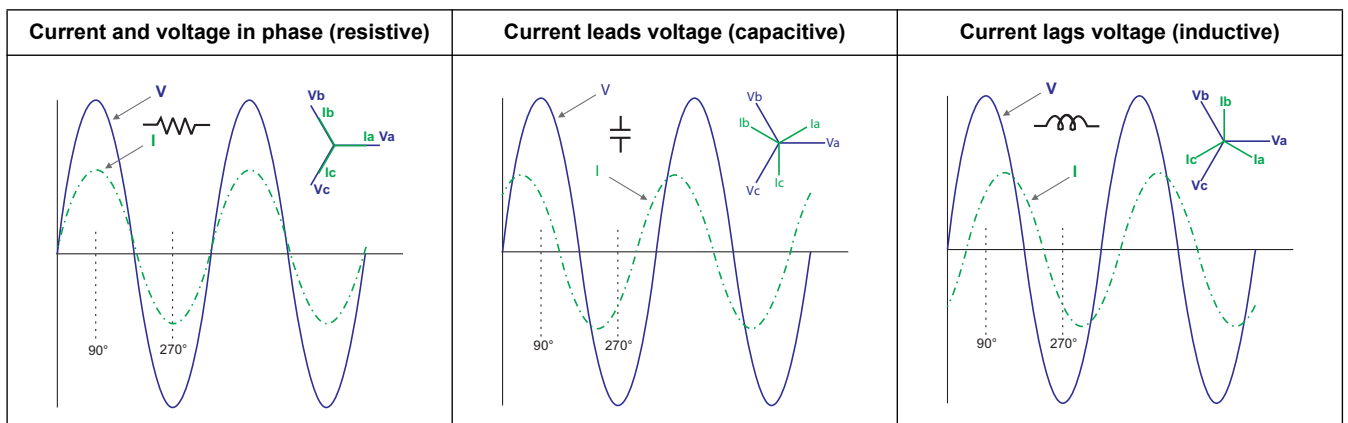

Power and PF lead / lag

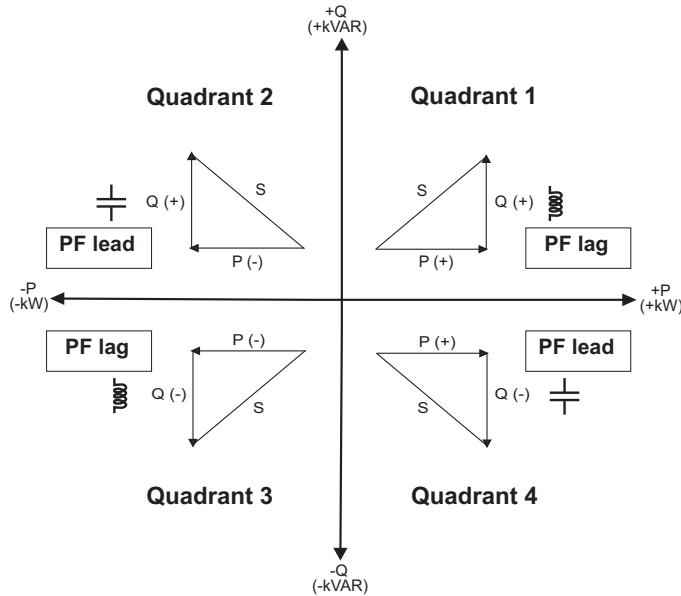

PF lead / lag summary

Quadrant	Current phase shift	Load type	PF lead / lag
Quadrant 1	Current lags voltage	Inductive	PF lag
Quadrant 2	Current leads voltage	Capacitive	PF lead
Quadrant 3	Current lags voltage	Inductive	PF lag
Quadrant 4	Current leads voltage	Capacitive	PF lead

PF sign convention

The meter shows positive or negative power factor according to IEC standards.

PF sign in IEC

The meter correlates power factor sign (PF sign) with the direction of real power (P) flow.

- For positive real power (+P), the PF sign is positive (+).
- For negative real power (-P), the PF sign is negative (-).

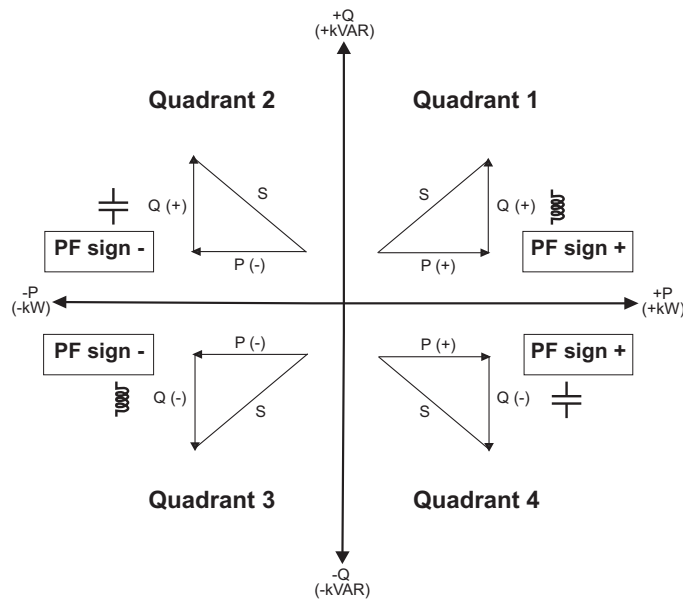

Power factor register format

Each power factor value (PF value) occupies one floating point register for power factor (PF register). The meter performs a simple algorithm to the PF value then stores it in the PF register. The meter and software interpret the PF register for all reporting or data entry fields according to the following diagram:

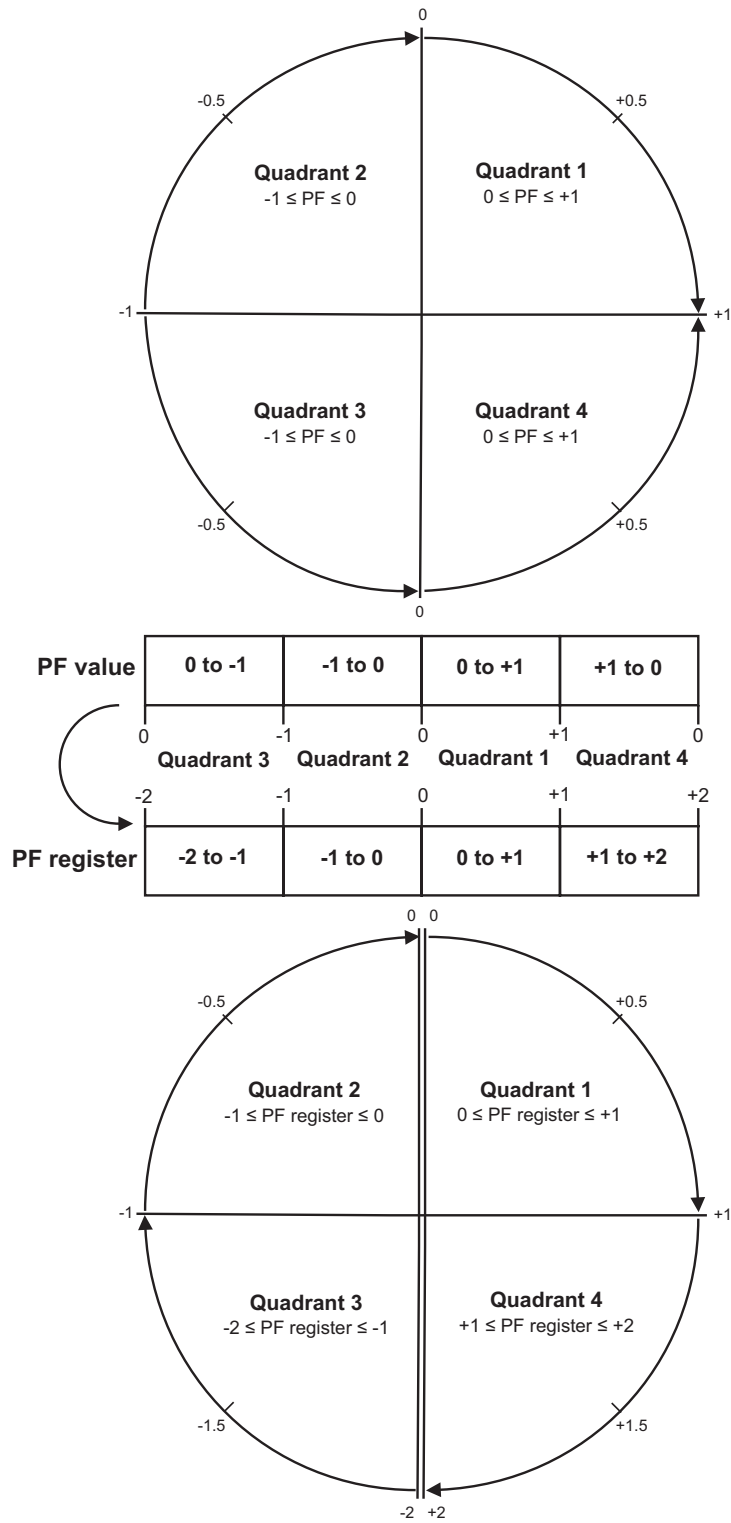

PF value is calculated from the PF register value using the following formulas:

Quadrant	PF range	PF register range	PF formula
Quadrant 1	0 to +1	0 to +1	PF value = PF register value
Quadrant 2	-1 to 0	-1 to 0	PF value = PF register value
Quadrant 3	0 to -1	-2 to -1	PF value = (-2) - (PF register value)
Quadrant 4	+1 to 0	+1 to +2	PF value = (+2) - (PF register value)

Related topics

- See the section for the applicable protocol for more information on the registers for that protocol.

Schneider Electric

35, rue Joseph Monier

CS30323

F - 92506 Rueil Malmaison Cedex

www.schneider-electric.com

As standards, specifications and designs change from time to time, please ask for confirmation of the information given in this publication.

© 2014 Schneider Electric. All rights reserved.

DOCA0005EN-04 – 04/2014